

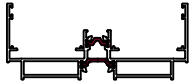









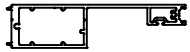

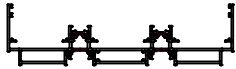

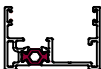

MINIMALISTA
elipse

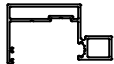

Referencia	Dibujo	Descripción	Momento de Inercia cm ⁴		Perímetro dm ²
			lx	ly	
1000		Marco 2 carriles minimalista	9,78	97,59	80,4
1001		Hoja lateral / inferior (BIMETAL)	6,32	7,94	40,0
1002		Hoja centro	1,21	14,58	31,6
1003		Hoja centro refuerzo	6,57	93,85	56,5
1004		Carril de rodadura	0,02	0,12	4,4
1005		Hoja centro / superior	1,32	5,03	24,8
1006		Marco 3 carriles minimalista	12,49	329,59	120,6

Referencia	Dibujo	Descripción	Momento de Inercia cm ⁴		Perímetro dm ²
			lx	ly	
1007		Hoja lateral / inferior	6,32	7,94	40,0
1008		Marco monocarril minimalista	8,71	16,41	56,4
1009		Perfil unión 4 hojas	2,76	11,88	36,3
1010		Suplemento carril de rodadura	0,58	3,21	18,1
1011		Junquillos acristalamiento monocarril	0,05	0,77	11,3
1012		Suplemento lateral cerradero	0,15	1,97	14,3
1013		Unión marco en esquina	2,21	19,37	46,7

Referencia	Dibujo	Descripción	Momento de Inercia cm ⁴		Perímetro dm ²
			lx	ly	
1014		Pilastra fijo integrado	5,67	19,37	45,8
1015		Tapeta hoja centro	0,02	0,54	8,3
1016		Tapa marco lateral	1,16	4,22	20,6
1017		Galandage	2,11	16,06	32,5
1018		Tapeta galandage	6,87	22,53	35,5
1019		Canal portarejilla	45,74	122,77	63,2
1020		Suplemento carril embutido	8,22	66,57	67,4

1008 Marco monocarril minimalista

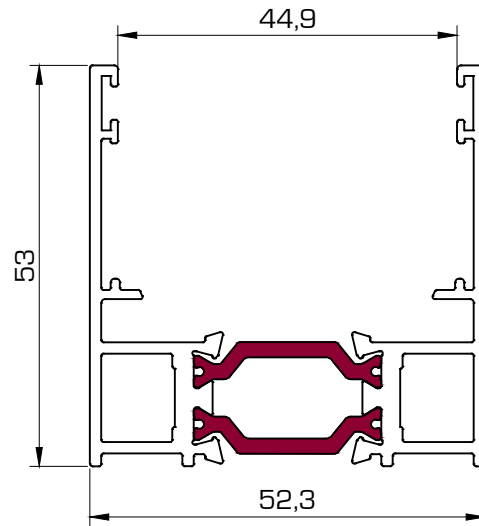

1000 Marco 2 carriles minimalista

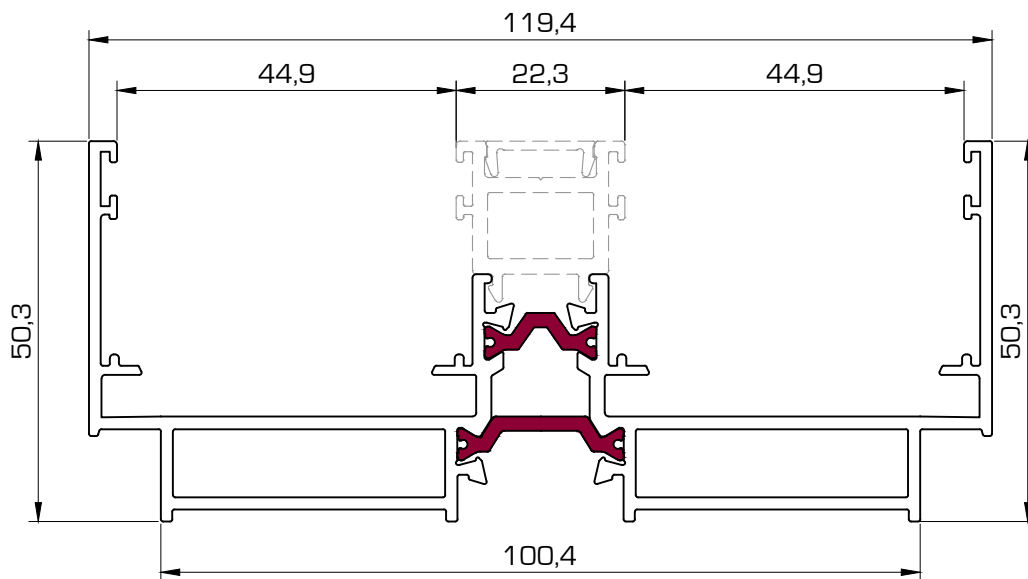

1006 Marco 3 carriles minimalista

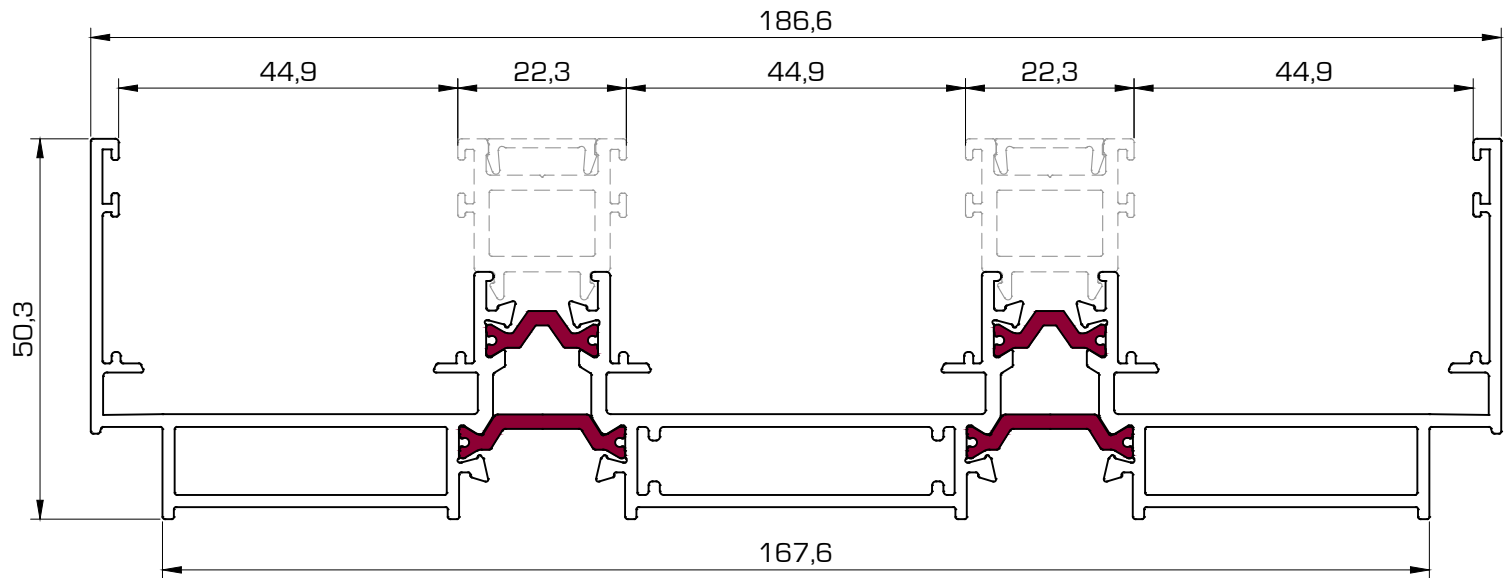

PO-145 Tapeta poliamida marco

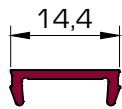

PO-223 Poliamida marco

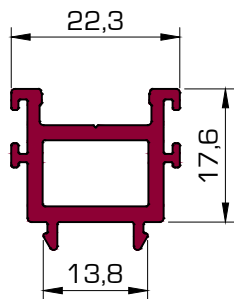

1016 Tapeta marco lateral

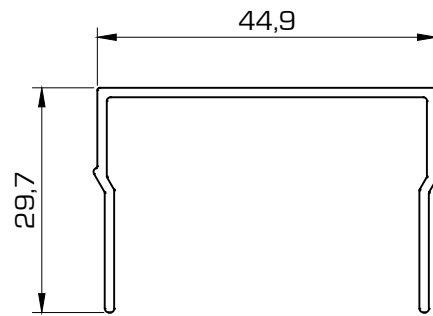

1007 Hoja lateral / inferior

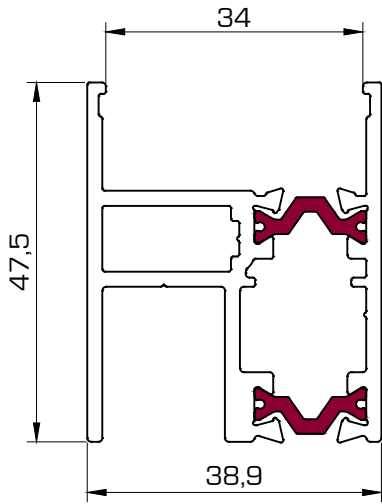

1001 Hoja lateral / inferior (BIMETAL)

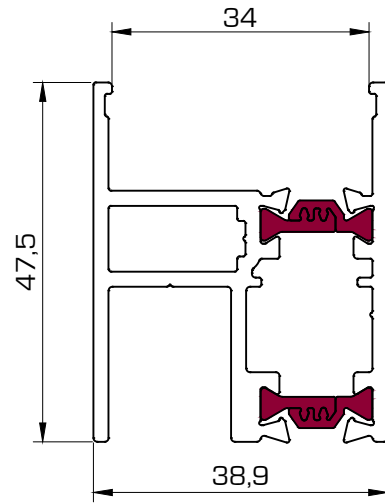

1027 Hoja lateral para cerradura

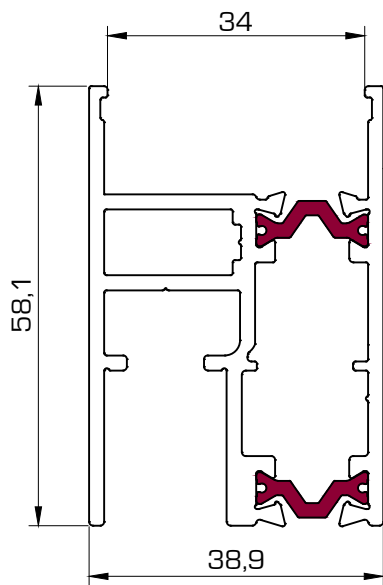

1021 Hoja lateral para cerradura (BIMETAL)

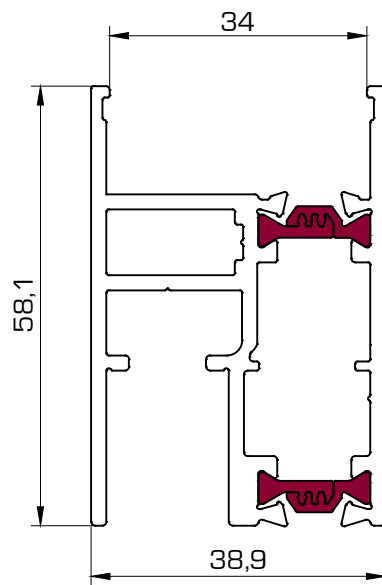

1005 Hoja centro / superior

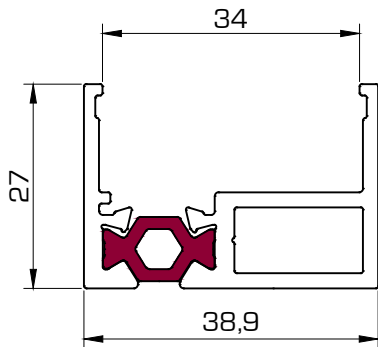

1009 Perfil unión 4 hojas

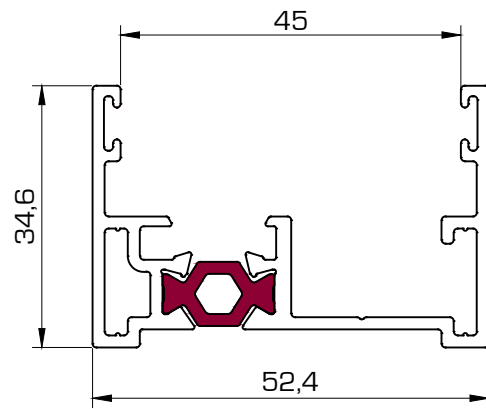

1003 Hoja centro refuerzo

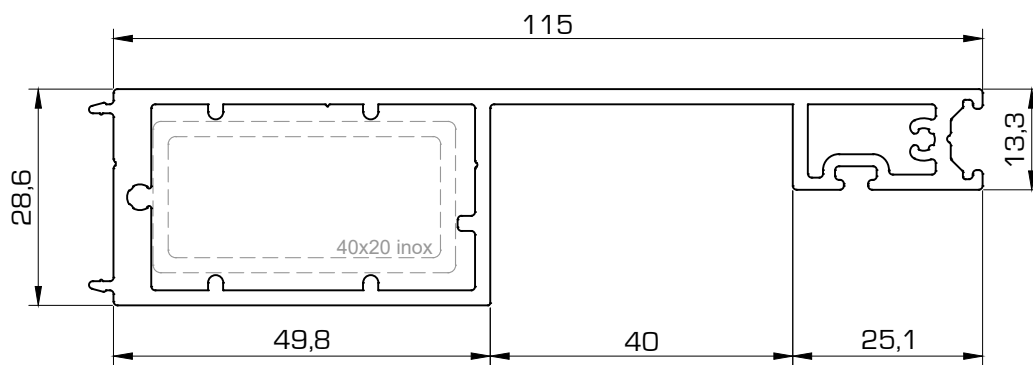

1002 Hoja centro

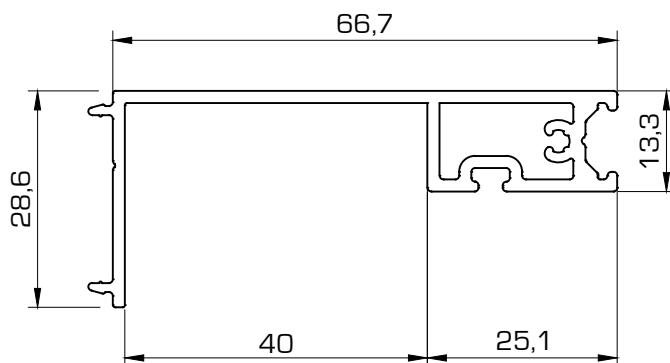

1015 Tapeta hoja centro

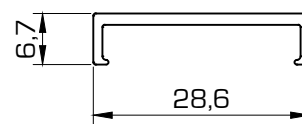

1017 Galandage

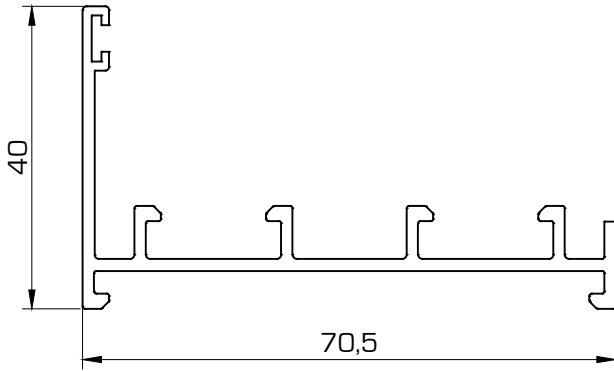

1018 Tapeta galandage

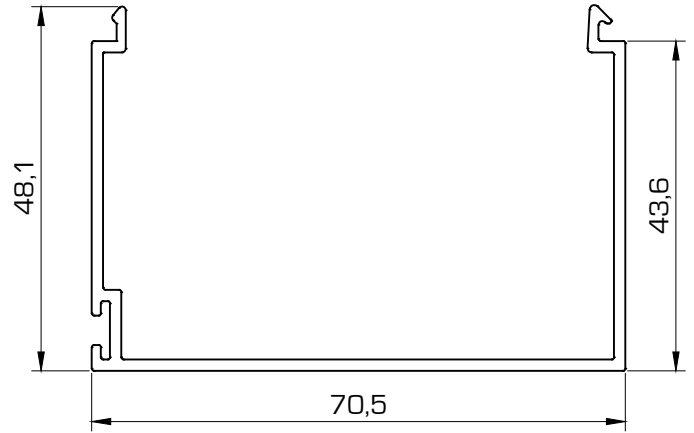

1010 Suplemento carril rodadura

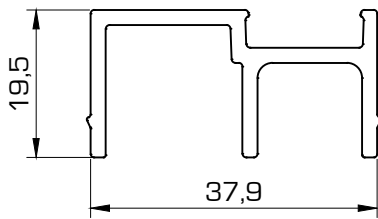

1004 Carril de rodadura

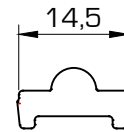

1012 Suplemento lateral cerradero

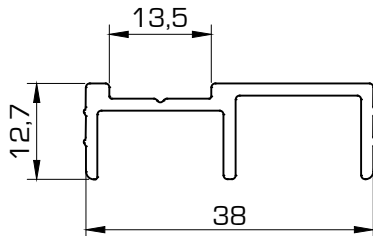

1011 Junquillo acristalado monocarril

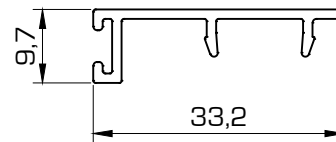

1014 Unión Marco en esquina

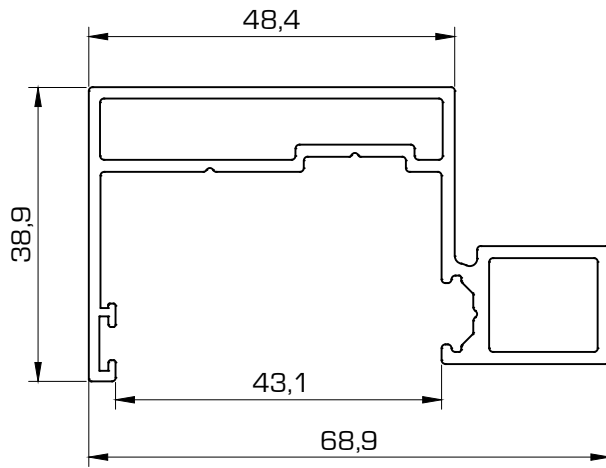

1013 Pilastra fijo integrado

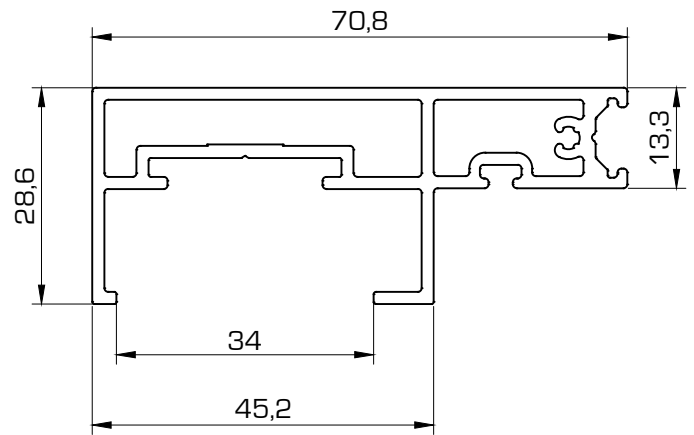

R010 Rejilla inox

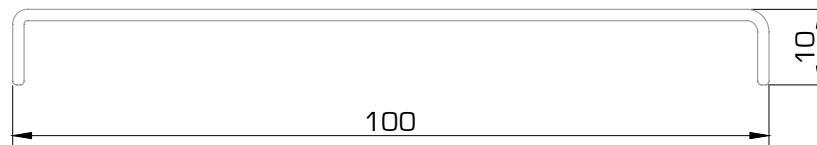

1019 Canal portarejilla

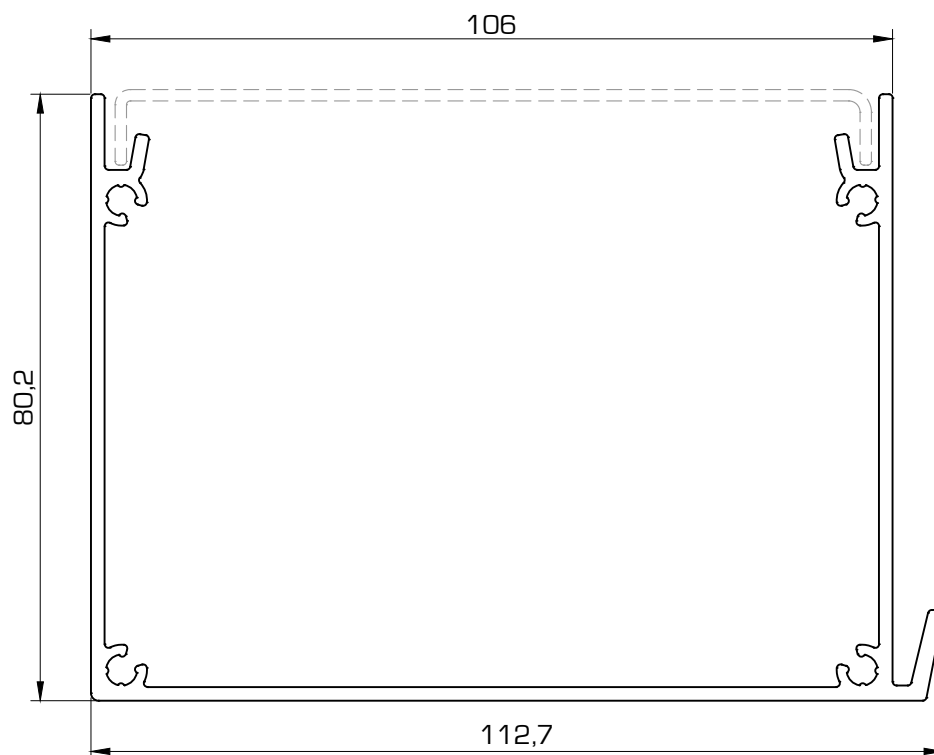



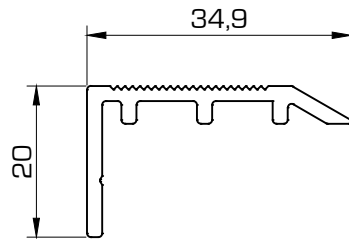



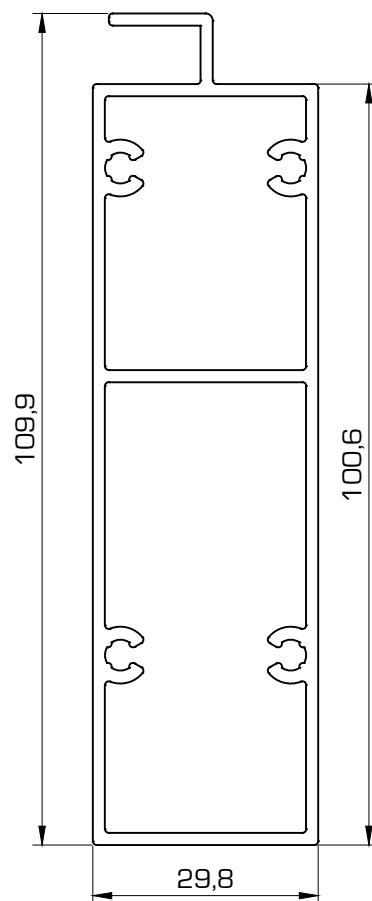

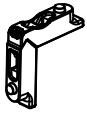
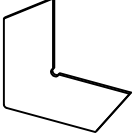
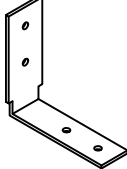

1022 Solape deslizante solera

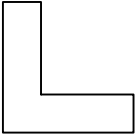



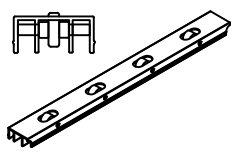
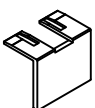
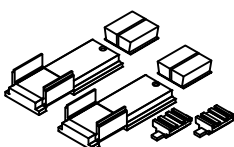
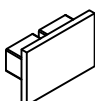

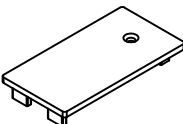
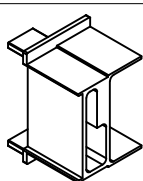



1020 Suplemento carril embutido

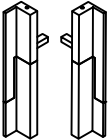

Referencia	Dibujo	Descripción	Observaciones
E041		Escuadra de 8,5 x 35,6	
E043		Escuadra de 8,2 x 16,4	
E048		Escuadra de 9 x 11,5	
E200		Escuadra alineación inox	
E201		Escuadra hoja fija	
E202		Escuadra marco galandage	
E203		Escuadra marco unión en esquina 120 x 120	
R052		Tandem graduable agujas (300 kg/hoja)	
R053		Rodamiento 4 ruedas fijo (300 kg/hoja)	

Referencia	Dibujo	Descripción	Observaciones
R100		Rodamiento lineal paso 100 (120 kg/m lineal de rod.)	
T202		Tapa hoja inglete	
K022		Kit juego cortavientos	
T203		Tapa hoja de rueda CR100	
T200		Tapa hoja centro interior	
T201		Tapa hoja centro exterior	
T205		Tapa hoja centro reforzada	
T204		Tapón unión 4 hojas	
G200		Junta unión 4 hojas	

Referencia	Dibujo	Descripción	Observaciones
F013		Cortavientos central	
F024		Felpudo hoja centro 10 x 6	
F026		Felpudo 7 x 6 TRIFIN	
F052		Felpudo hoja centro 5 x 6,5	
TI 1501D TI 1501I		Tirador 190 Derecha Tirador 190 Izquierda	
P100		Pletina rodamiento paso 100	
TA 7087		Tapa canal portarejilla	
R010		Rejilla Inox	

MULTIPUNTO CON LLAVE

MULTIPUNTO

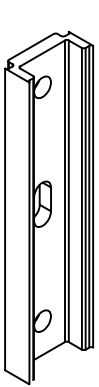

C337
Calzo para cerradero

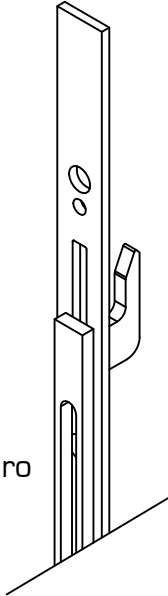

C700
Cerradero

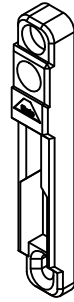

C701
Cerradero



C223
Multipunto central con llave

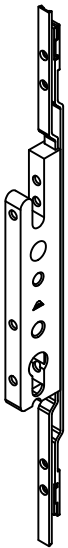

C224
Prolongador sup/inf
para llave



C221
Multipunto 600

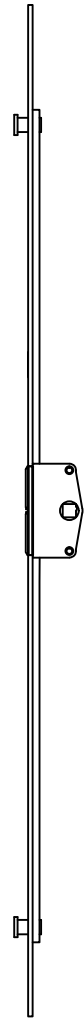

C222
Multipunto 1800

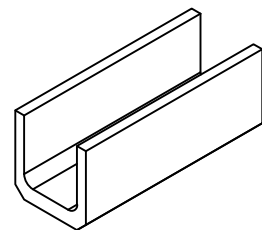

C331
Calzo multipunto



MECANIZADO PARA MULTIPUNTO PARA CERRADURA

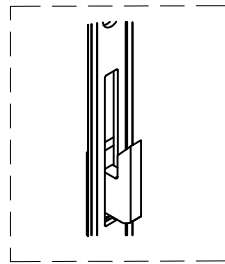
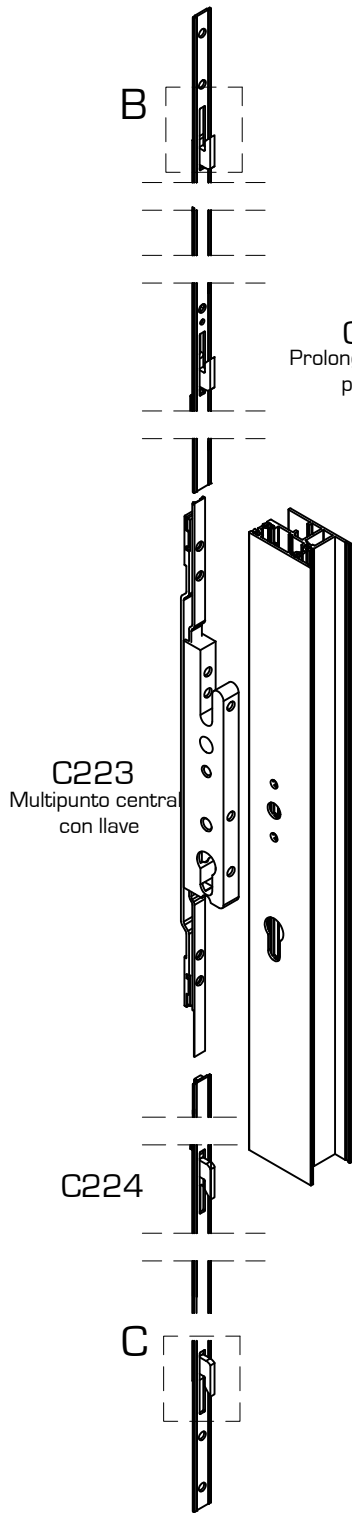

Detalle B.
Cierre hacia arriba

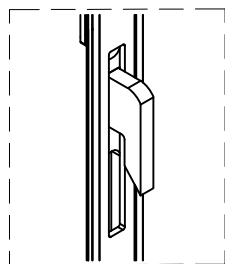

Detalle C.
Cierre hacia abajo

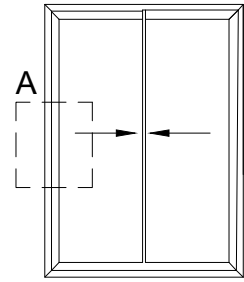

Detalle A

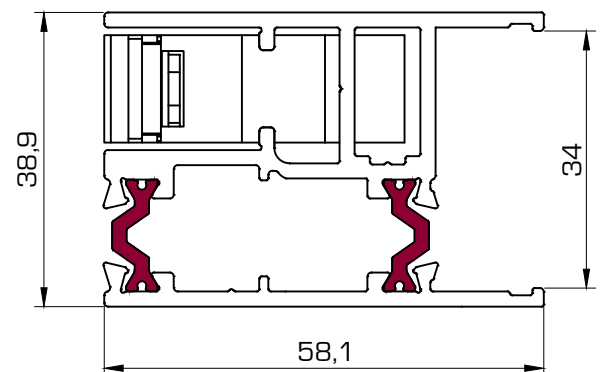
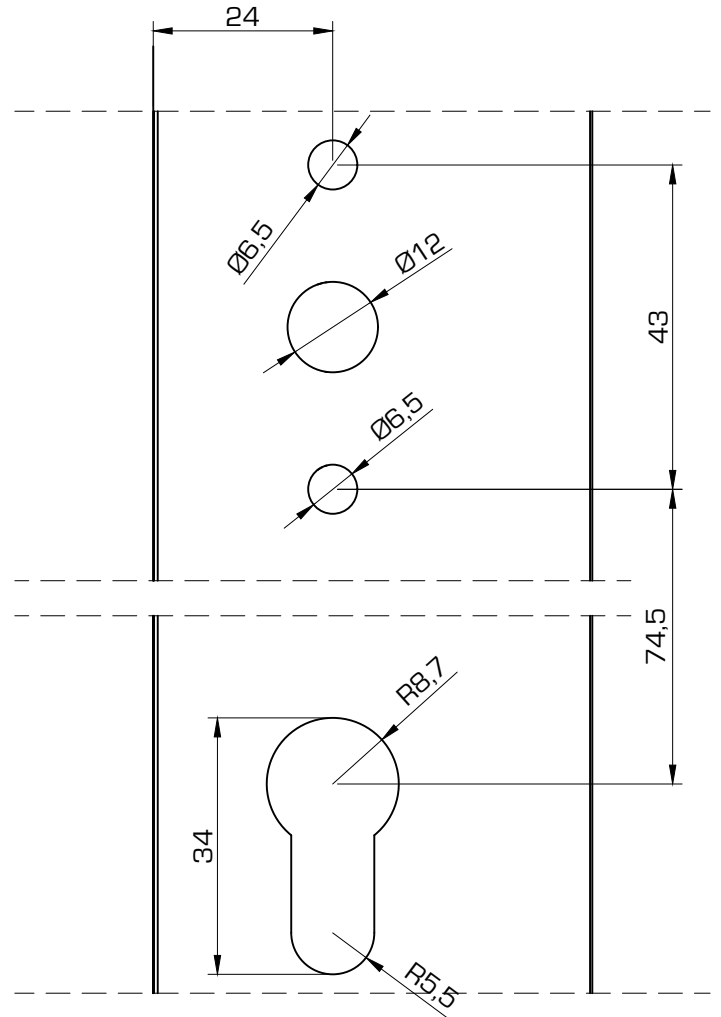

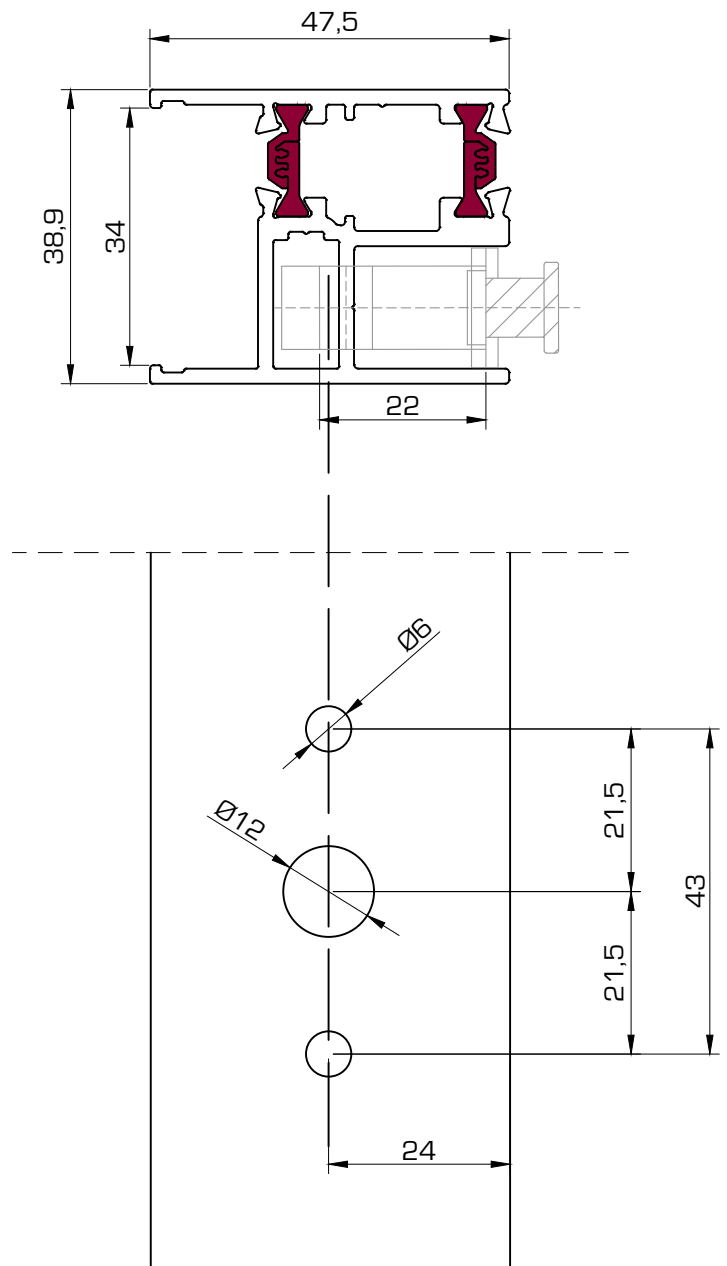
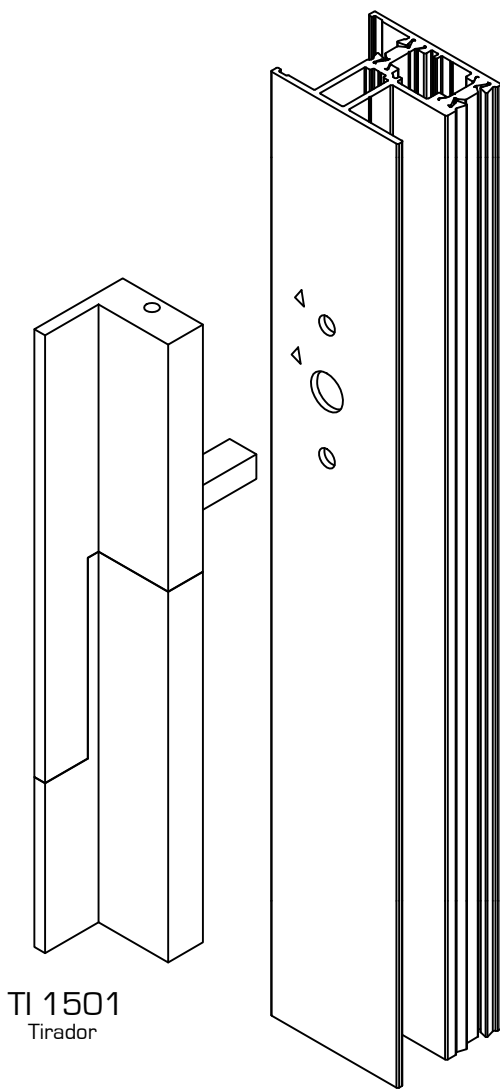
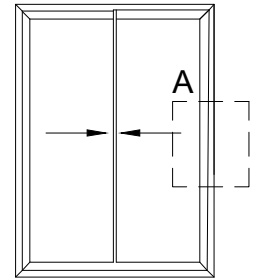

MONTAJE HOJA LATERAL CON RODAMIENTO PASO 100

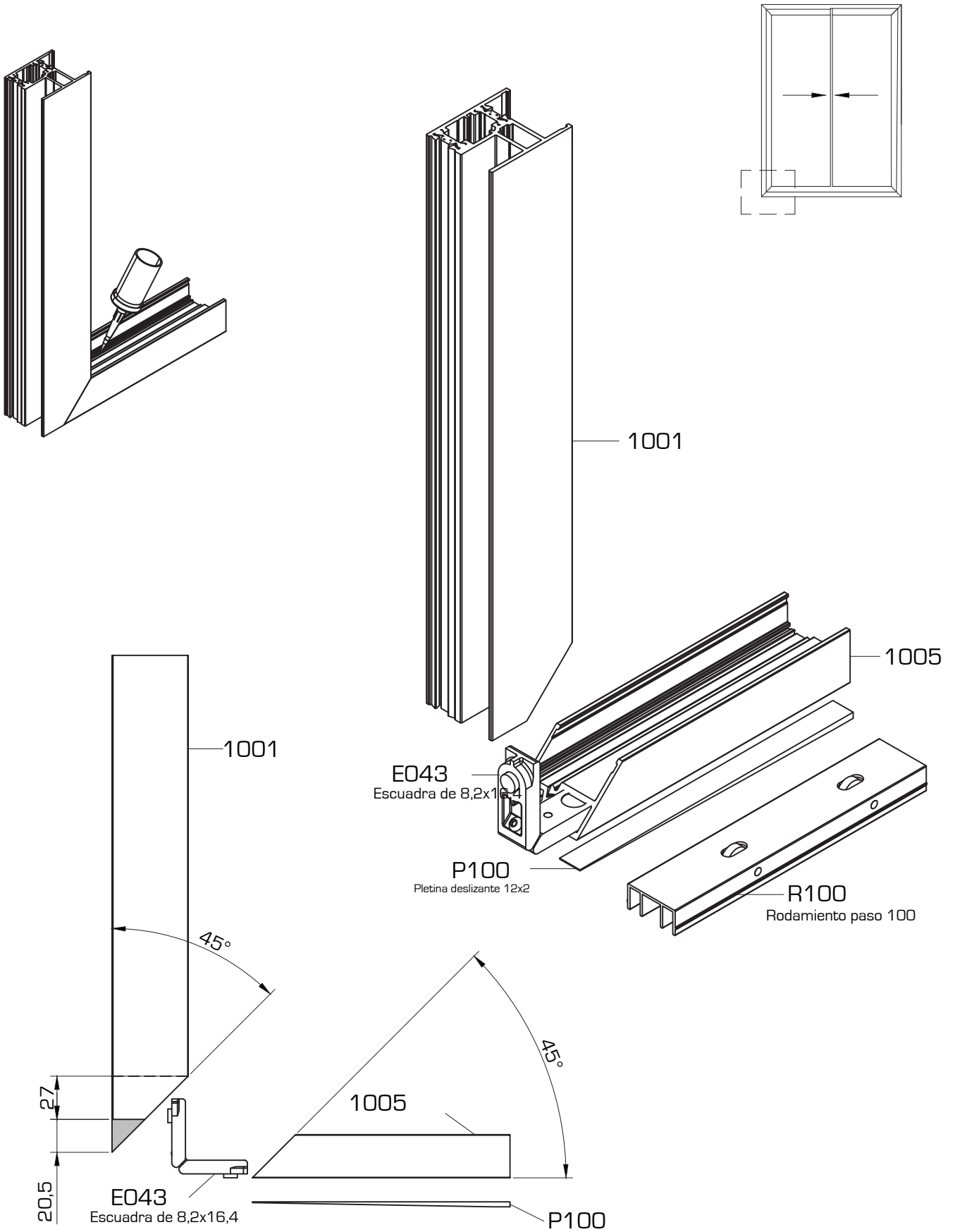

INGLETE HOJA CENTRO CON RODAMIENTO PASO 100

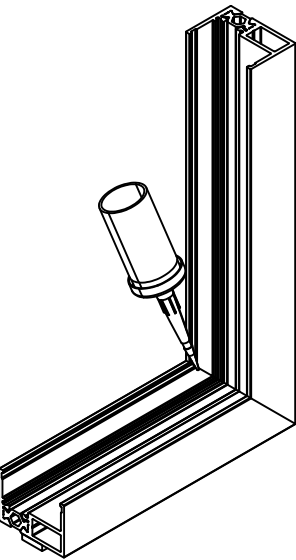

1005

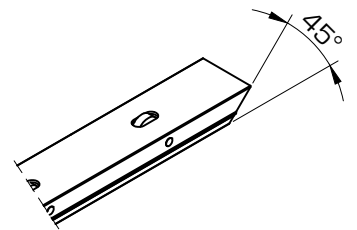
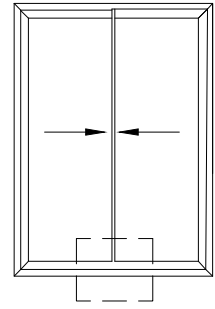

Detalle de Rodamiento: Corte a 45°

1005



E043

Escuadra de 8,2x16,4

P100

Pletina deslizante 12x2

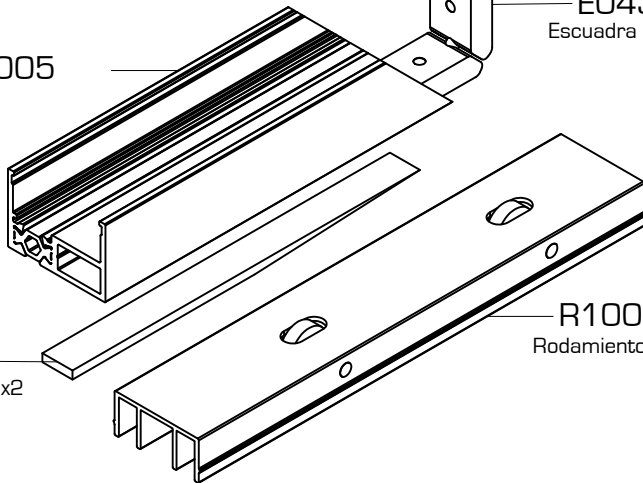

R100

Rodamiento paso 100

1005

45°

1005

45°

P100

Pletina deslizante 12x2



E043

Escuadra de 8,2x16,4

MONTAJE MARCO CON RODAMIENTO PASO 100

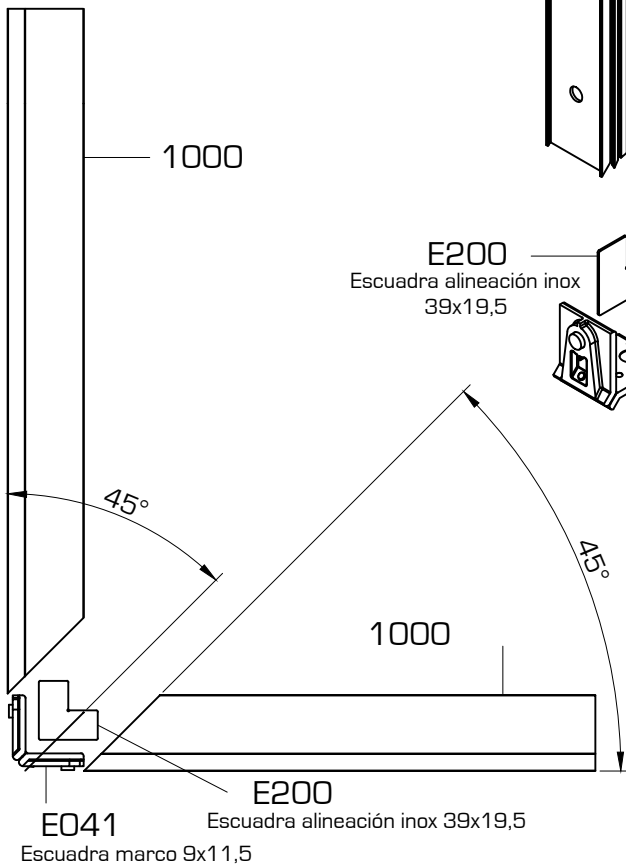
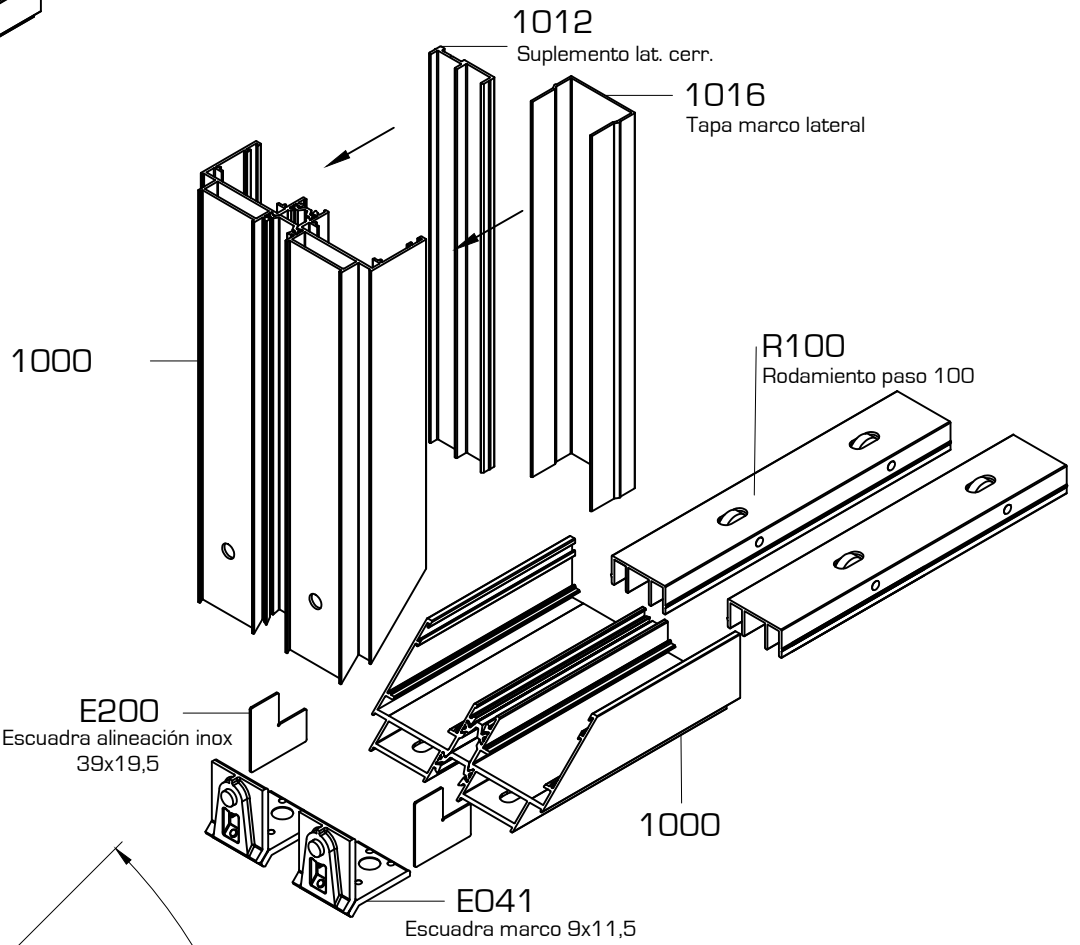
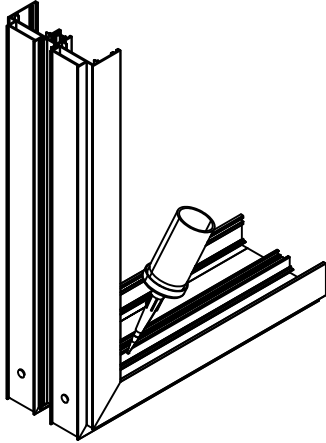
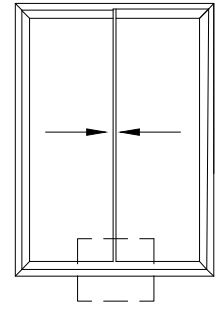

MONTAJE CORTAVIENTOS CENTRAL

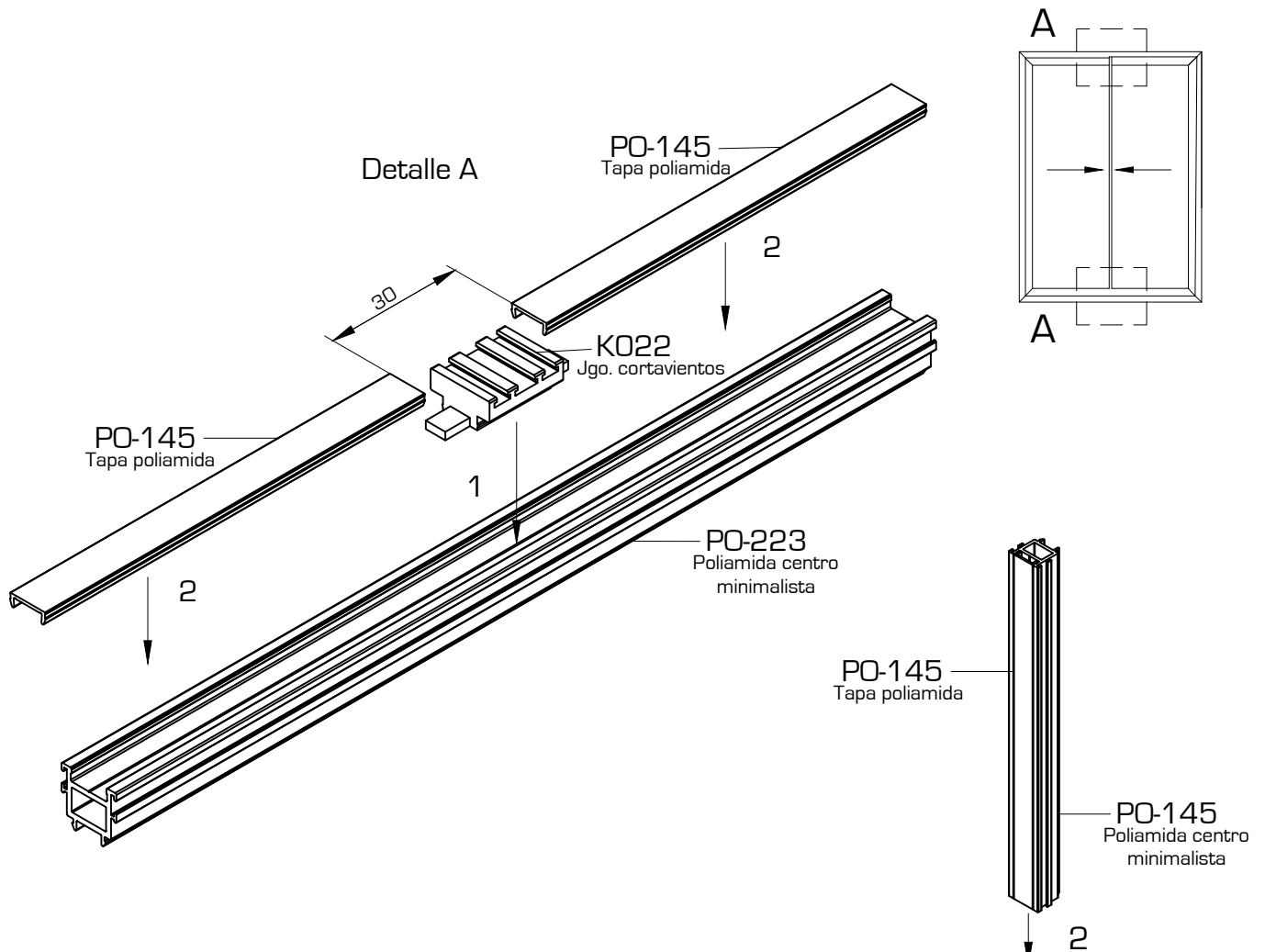

MONTAJE POLIAMIDAS GUÍA CETRAL

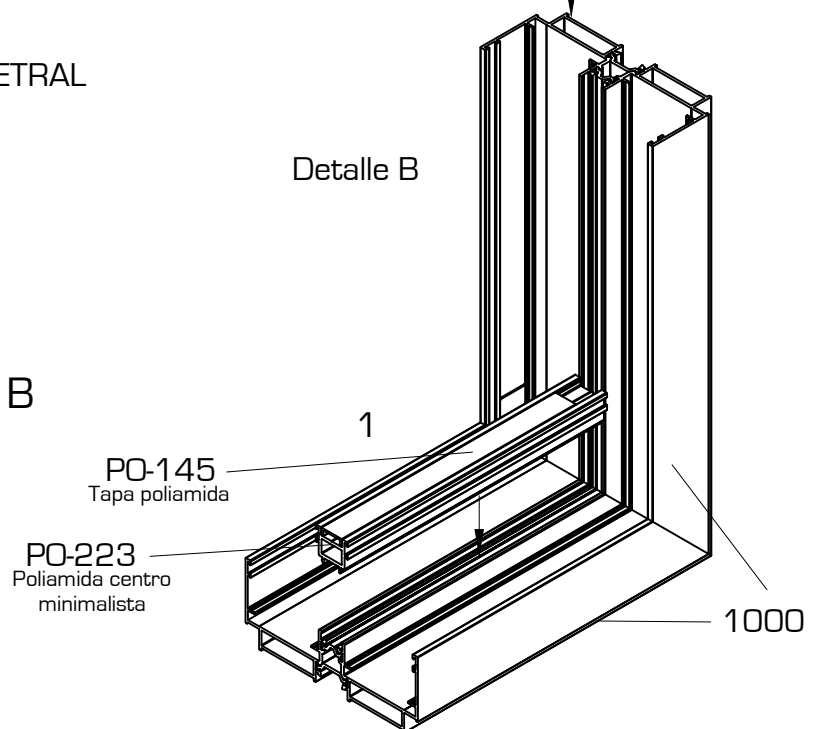
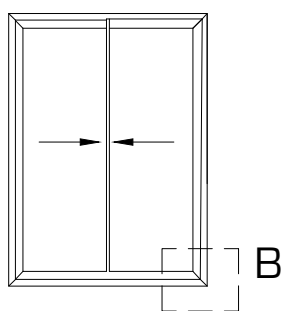

MONTAJE HOJA CON RODAMIENTO PASO 100

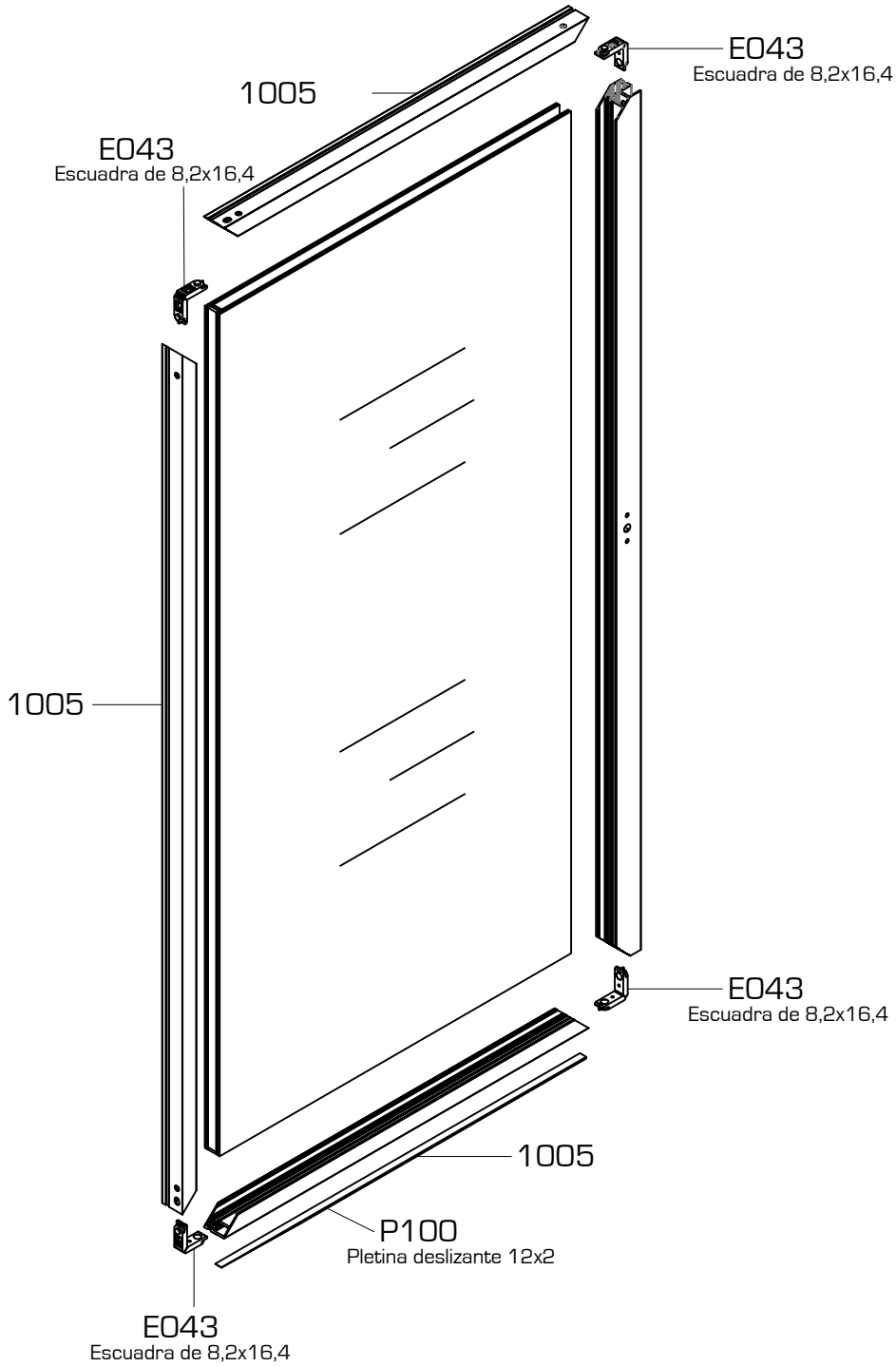
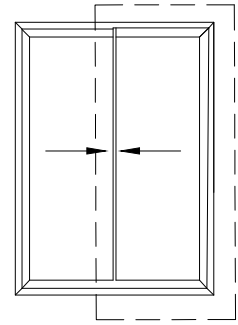

MONTAJE HOJA CON MULTIPUNTO CON RODAMIENTO PASO 100

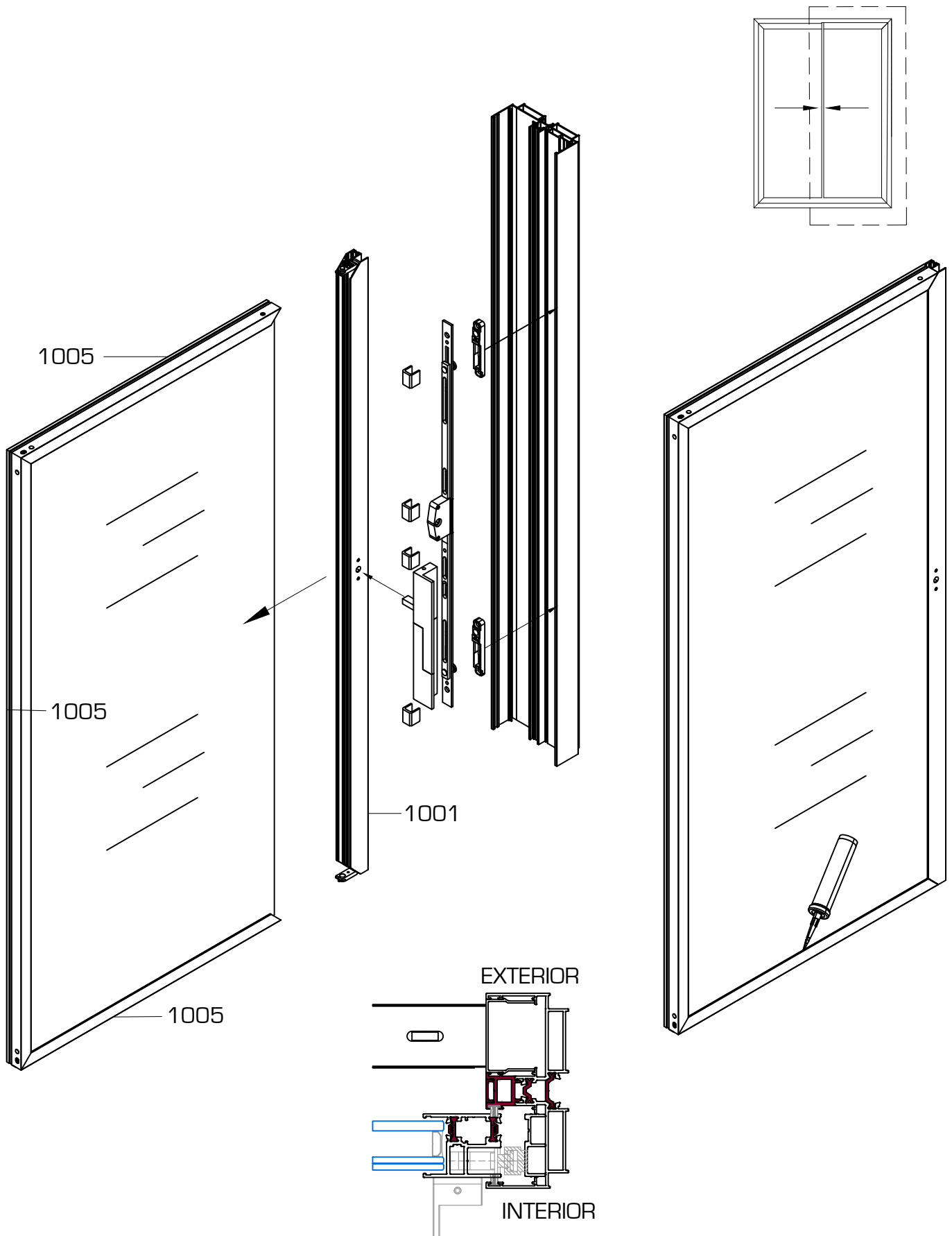

DETALLE MULTIPUNTO VARILLA 600

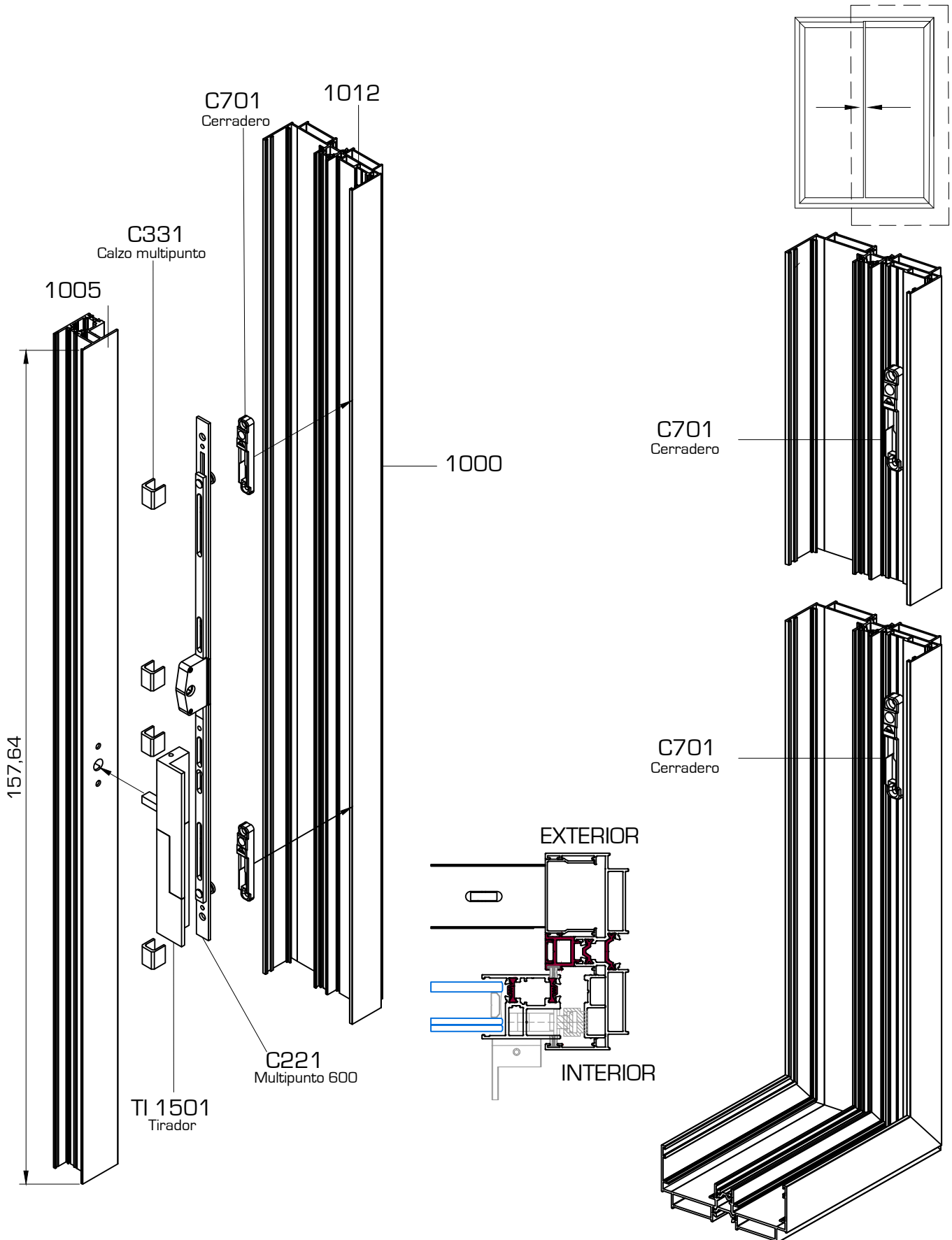

DETALLE MULTIPUNTO VARILLA 1800

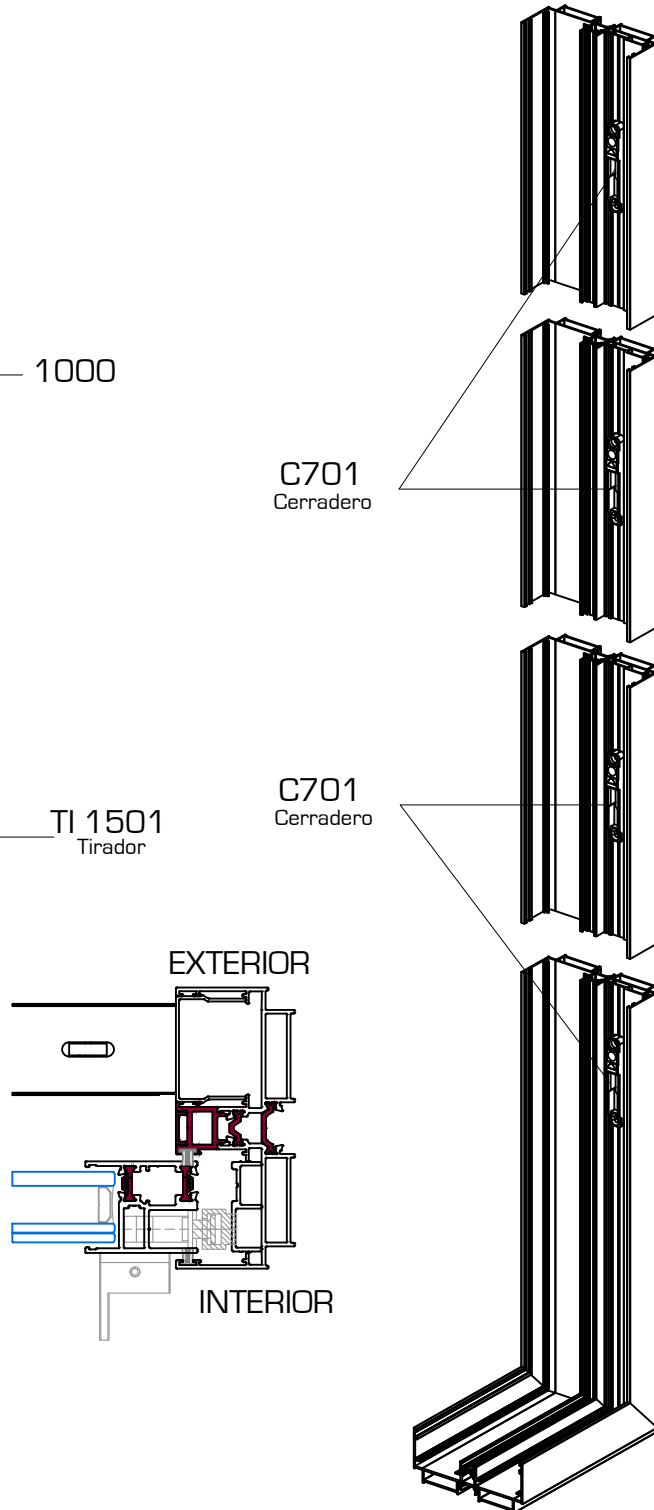
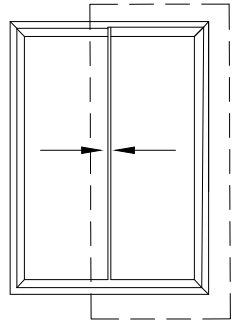
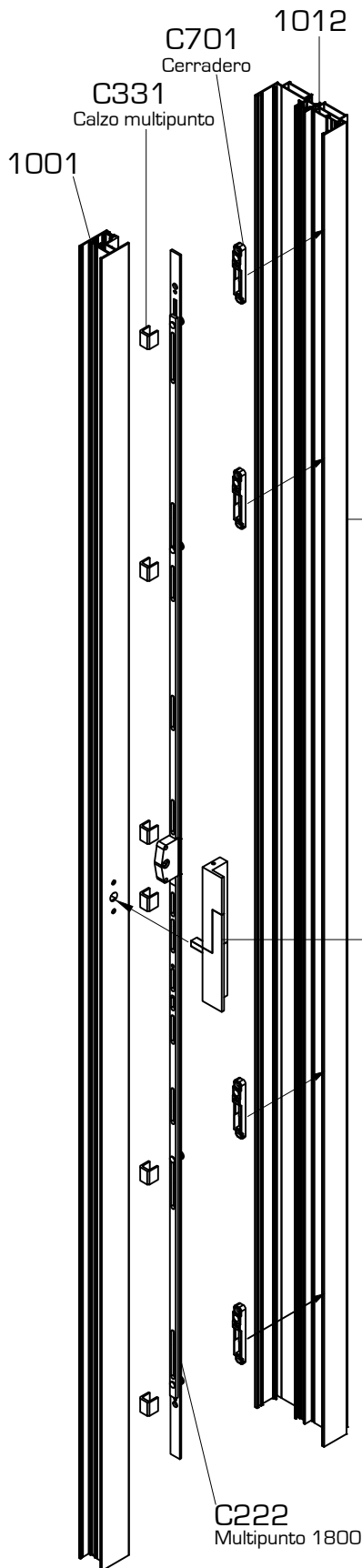

MONTAJE HOJA CENTRO DE 1 HOJA + FIJO

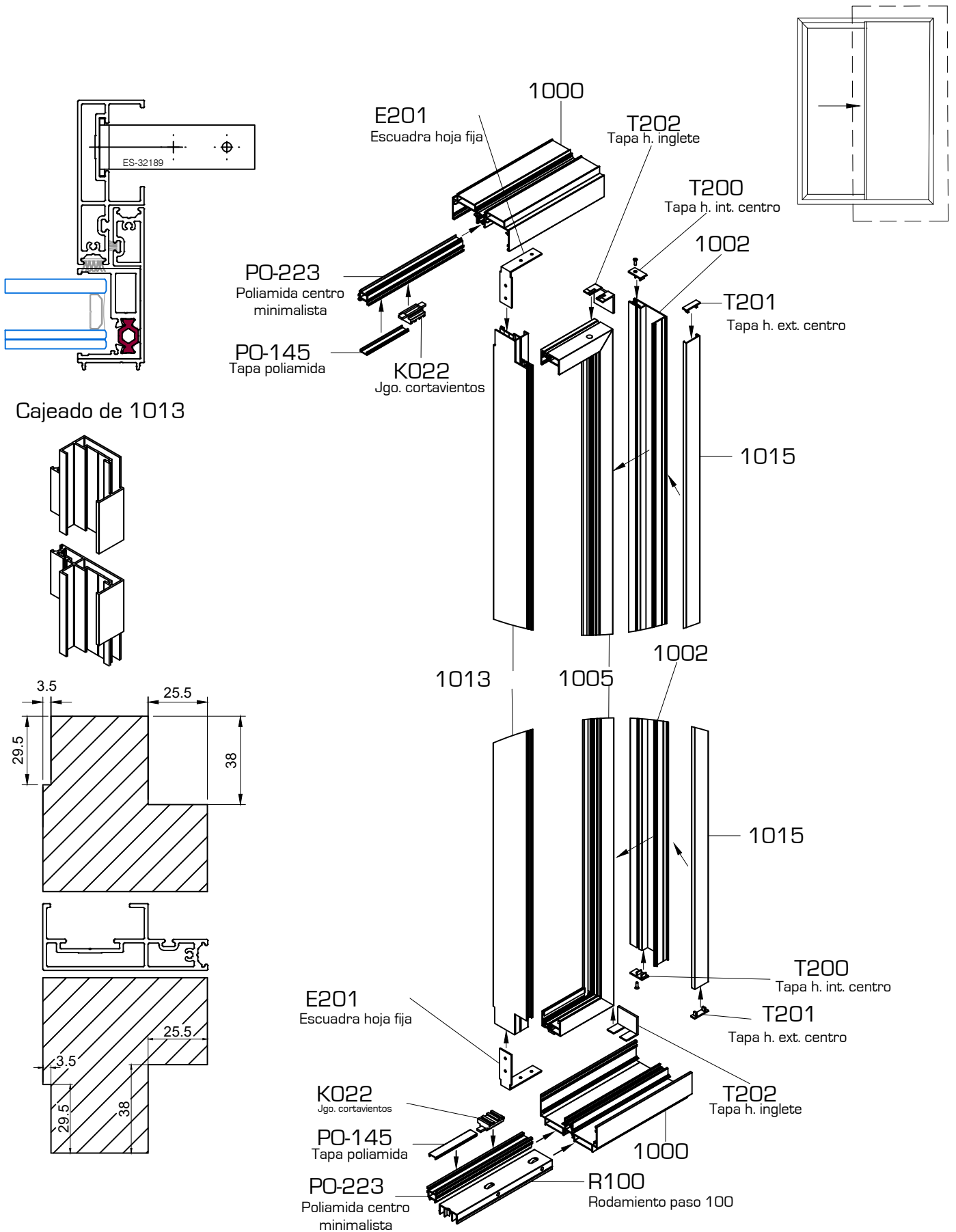

MONTAJE ENCUENTRO 4 HOJAS

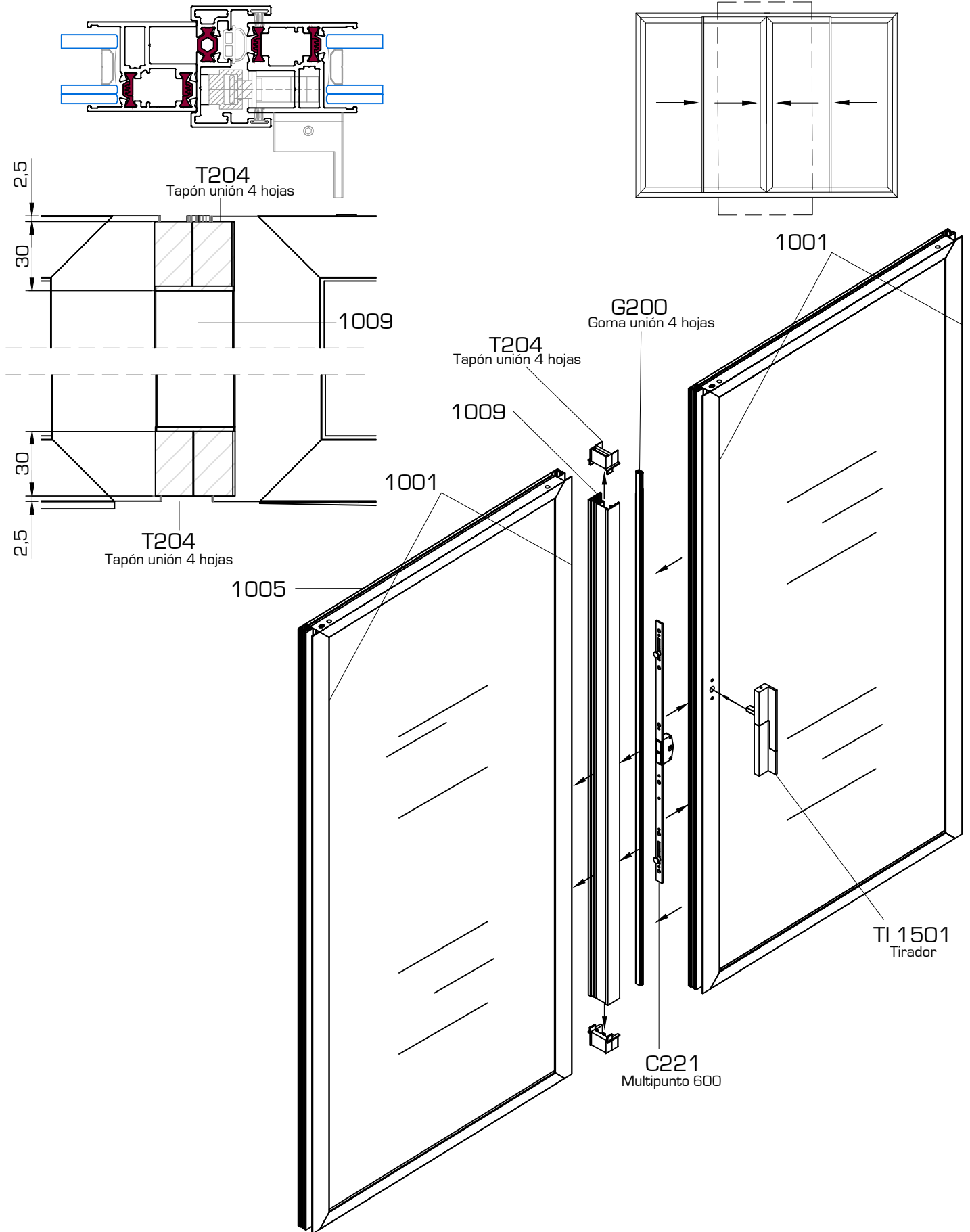

MONTAJE HOJA CENTRO CON RODAMIENTO PASO 100

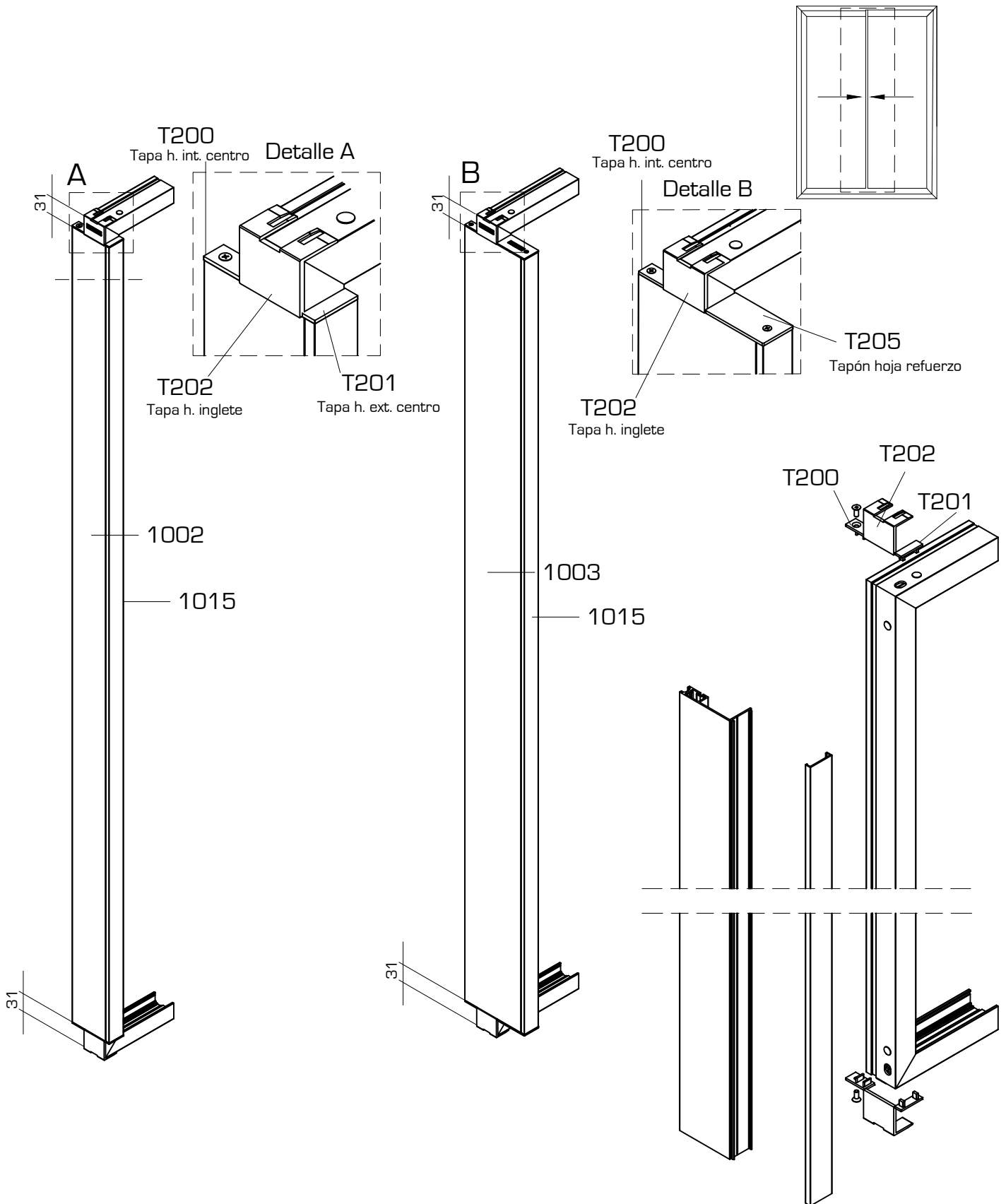

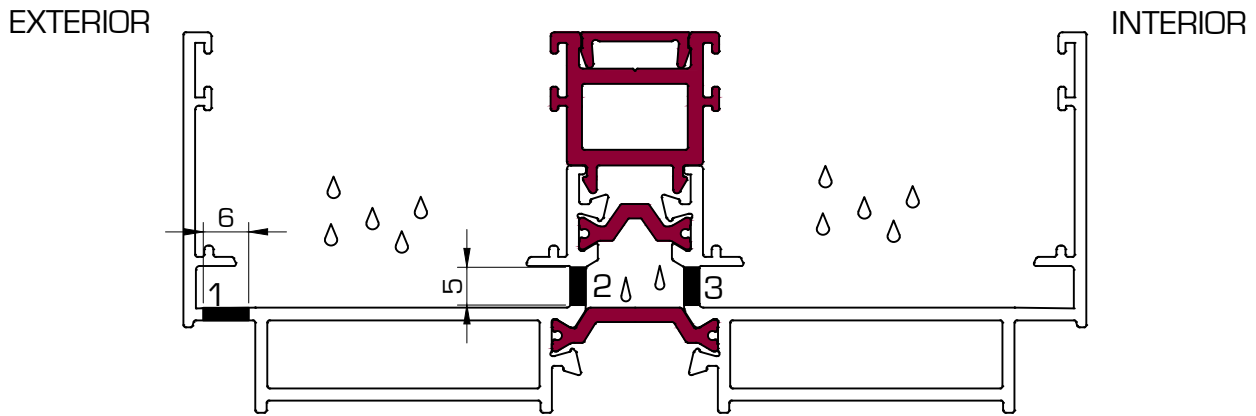

1. Troquelado dimensión 30x6 mm.
Situado a 75 mm del extremo y repetir cada 150 mm
2. Troquelado dimensión 20x5 mm.
Situado a 150 mm del extremo y repetir cada 300 mm
3. Troquelado dimensión 20x5 mm.
Situado a 75 mm del extremo y repetir cada 300 mm

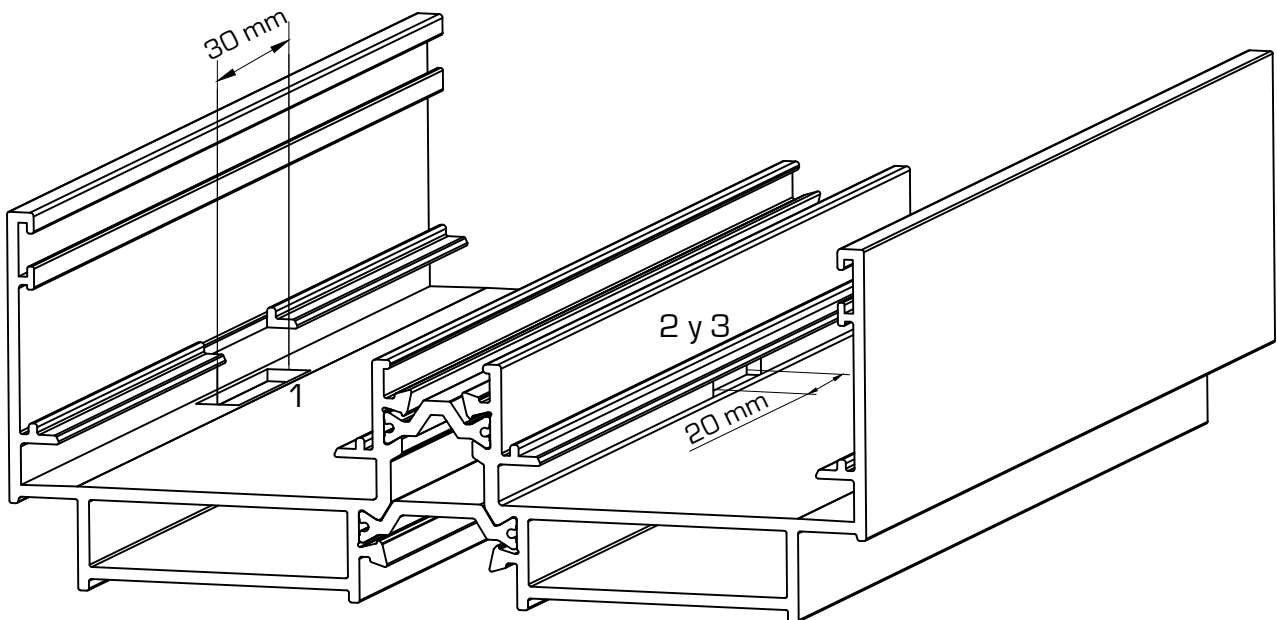

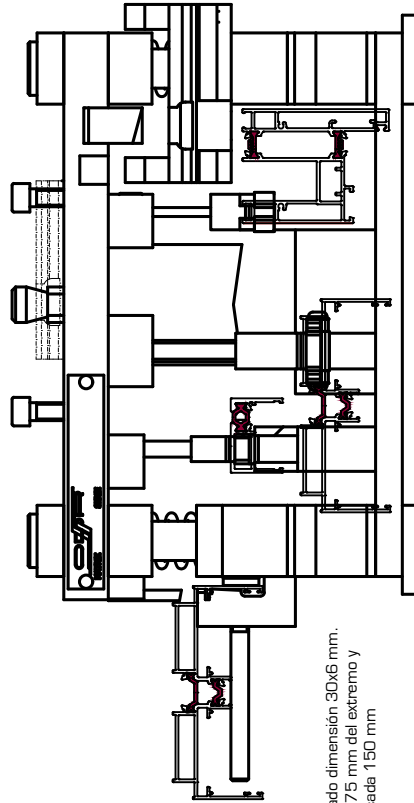
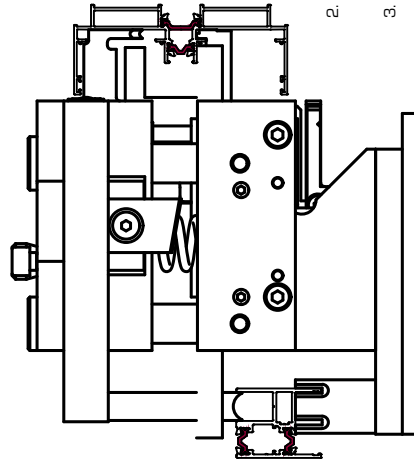
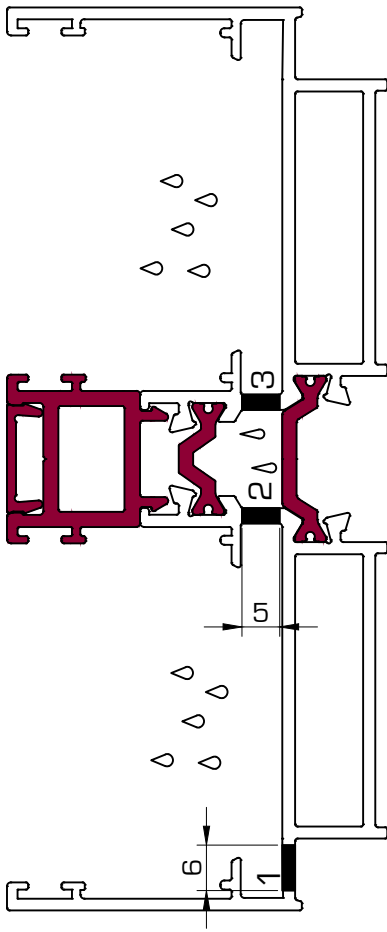

2. Troquelado dimensión 20x5 mm.
Situarse a 150 mm del extremo y
repetir cada 300 mm
3. Troquelado dimensión 20x5 mm.
Situarse a 75 mm del extremo y
repetir cada 300 mm

1. Troquelado dimensión 30x6 mm.
Situarse a 75 mm del extremo y
repetir cada 150 mm

EXTERIOR

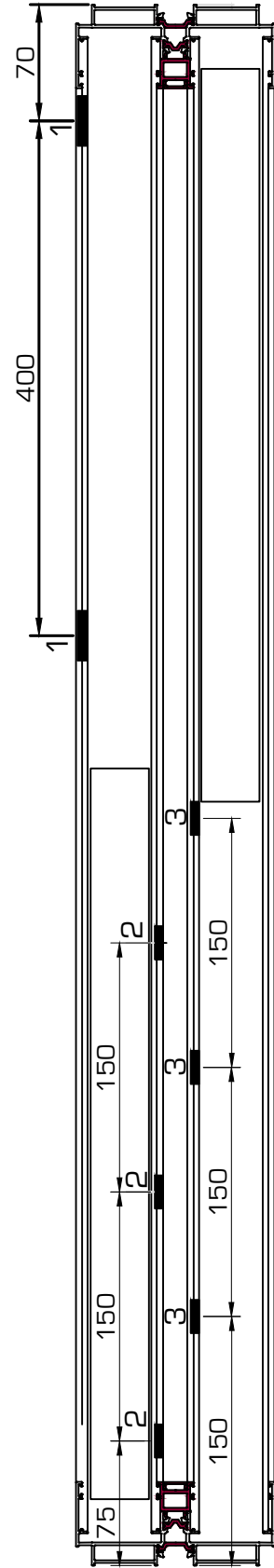

INTERIOR

Matriz abierta: 200 mm.
 Matriz cerrada: 175 mm.
 Recorrido: 25mm.
 Matriz 4 columnas
 Muelles de recuperación

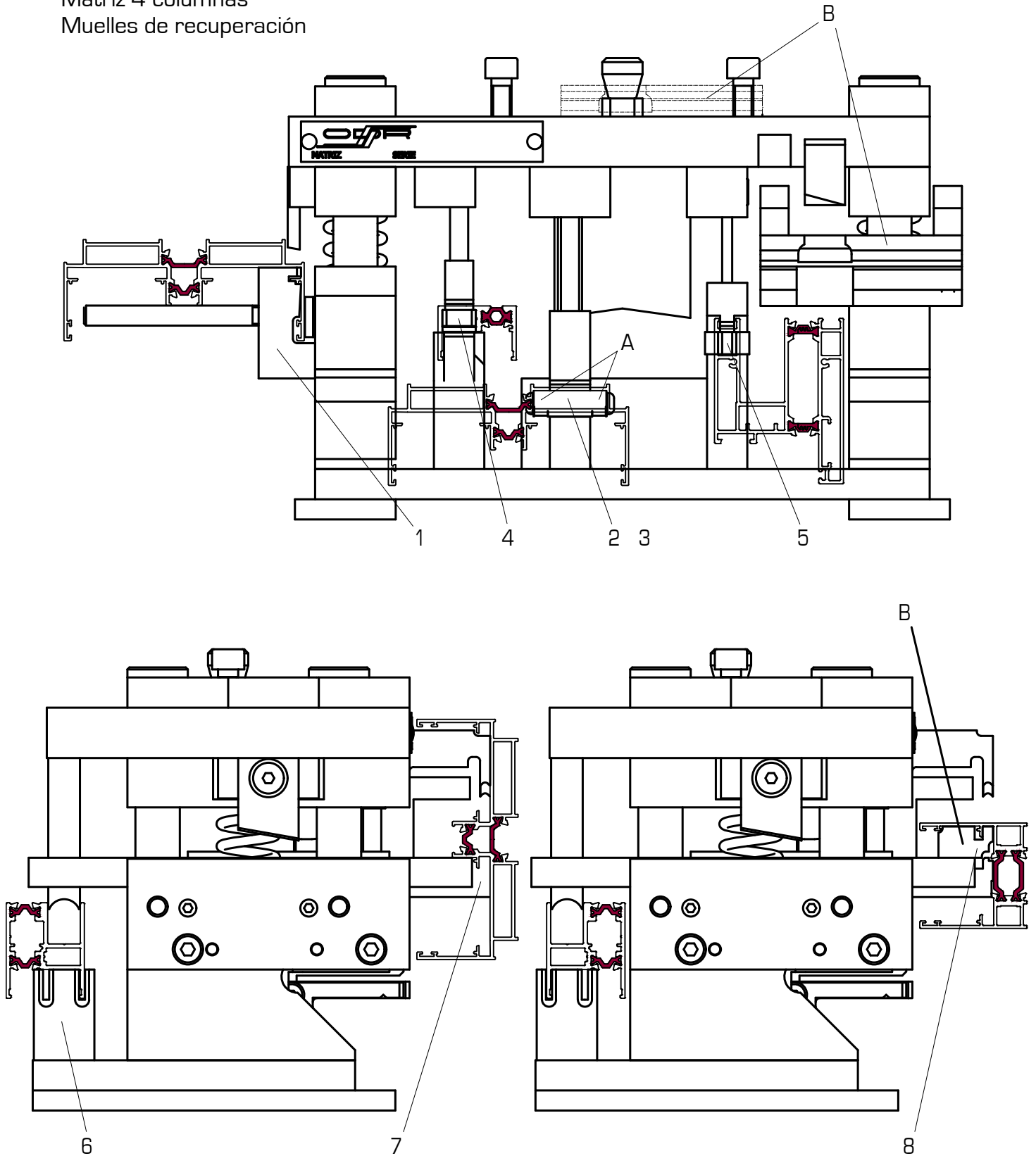

OPERACION 1:

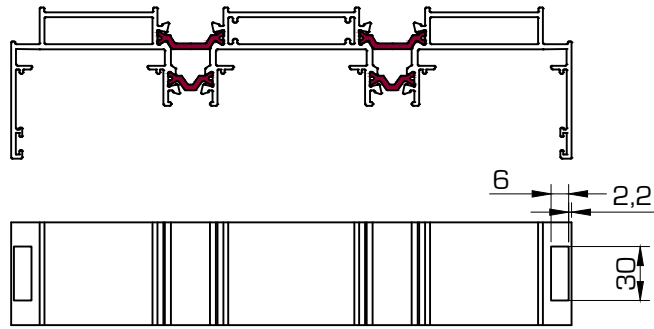

VIERTEAGUAS

PERFILES N°
1000
1006

OPERACION 2:

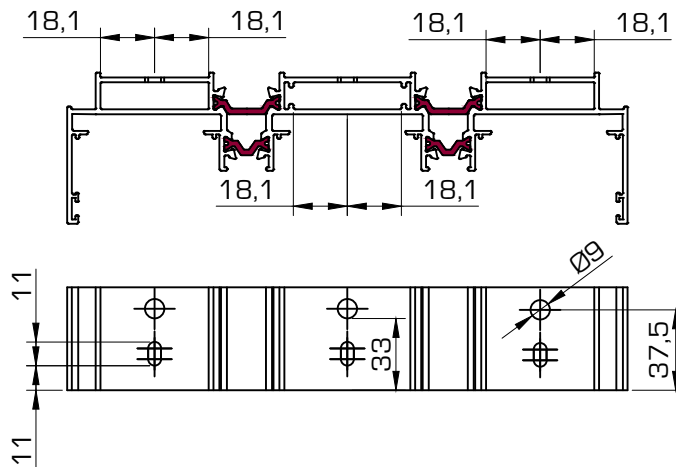

ESCUADRA INTERIOR
PLETINAS "A" ARRIBA

PERFILES N°
1000
1006

OPERACION 4:

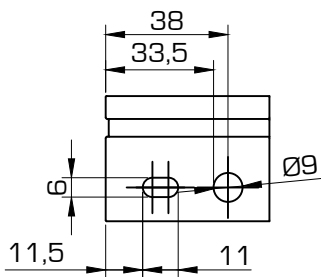

ESCUADRA

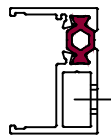

PERFILES N°
1007
1005

OPERACION 5:

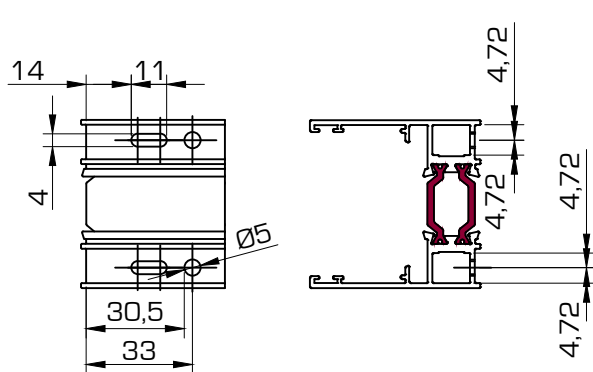

ESCUADRA

PERFILES N°
1008

OPERACION 6:

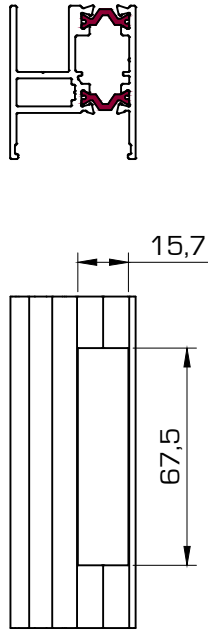

CAJEADO

PERFIL N°
1007

OPERACION 7:

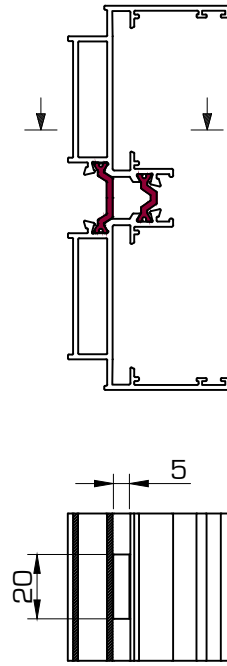

VIERTEAGUAS
SIN SUFRIDERA "B"

PERFILES N°
1000
1006

OPERACION 8:

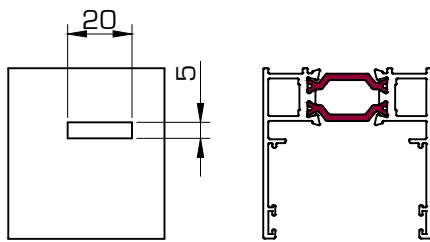

VIERTEAGUAS
CON SUFRIDERA "B"

PERFIL N°
1008

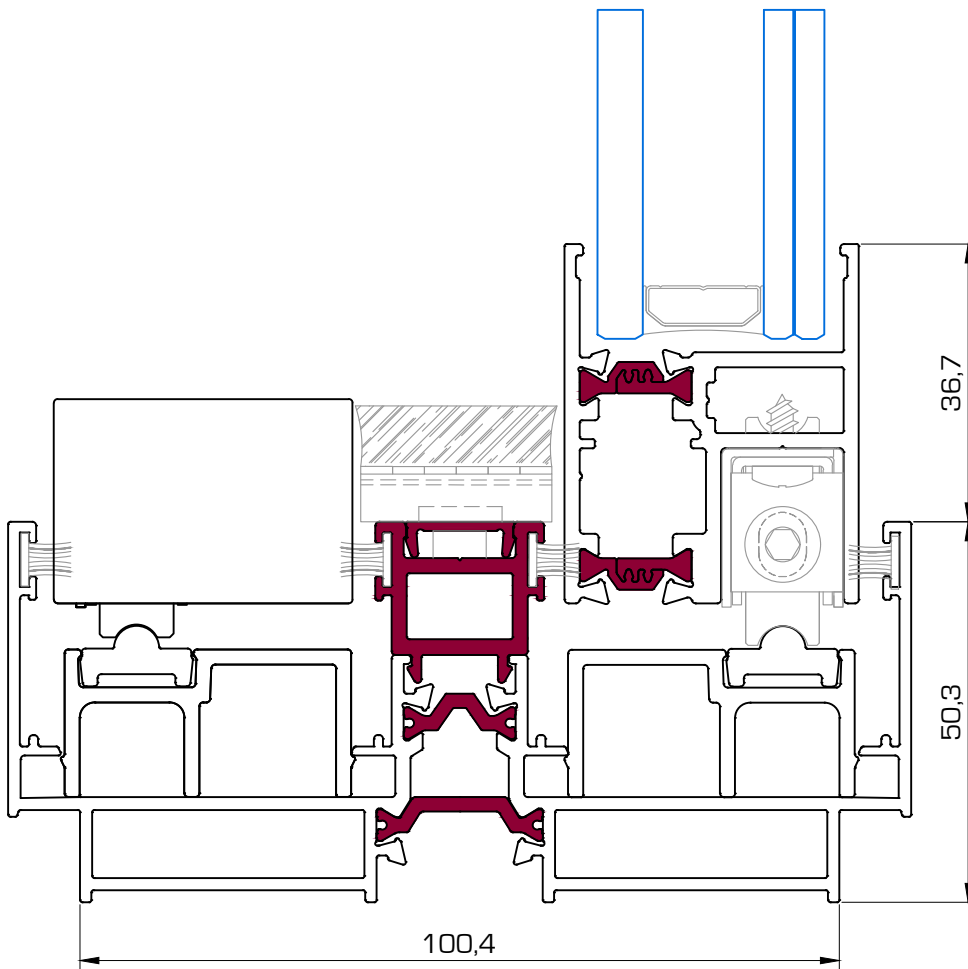
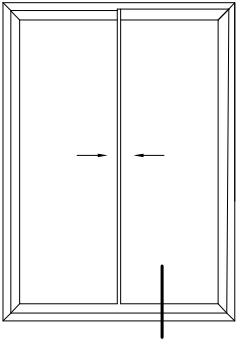

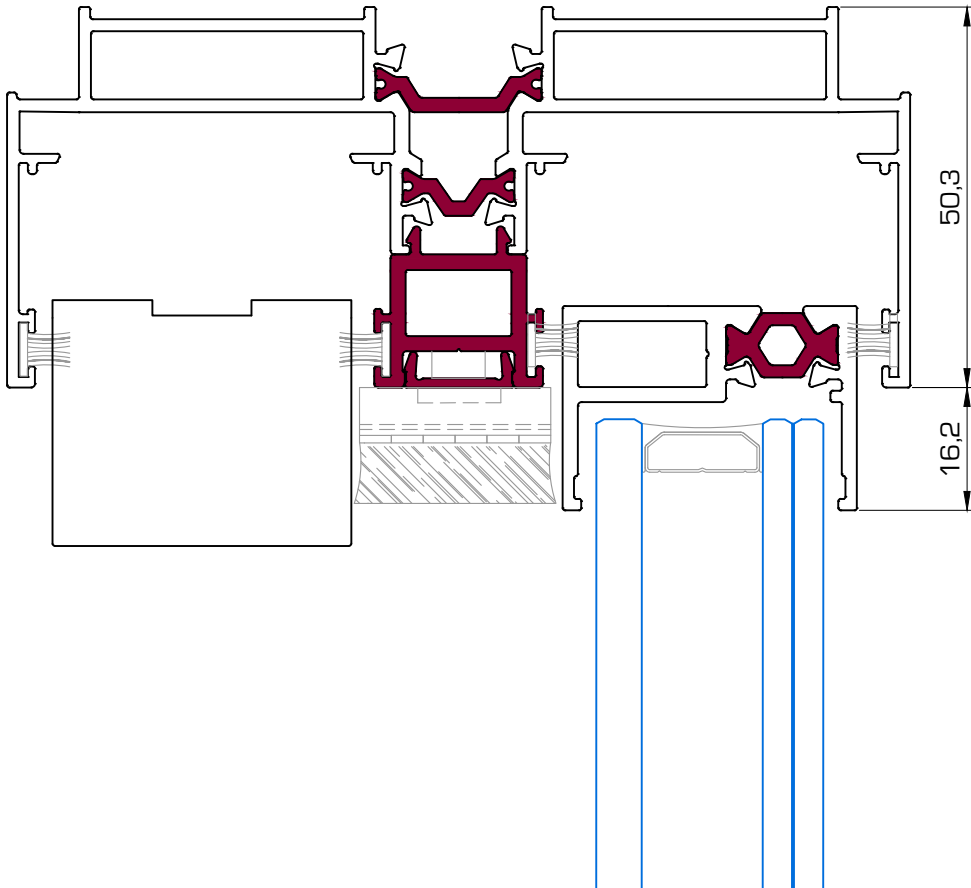
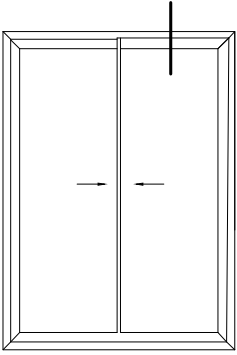

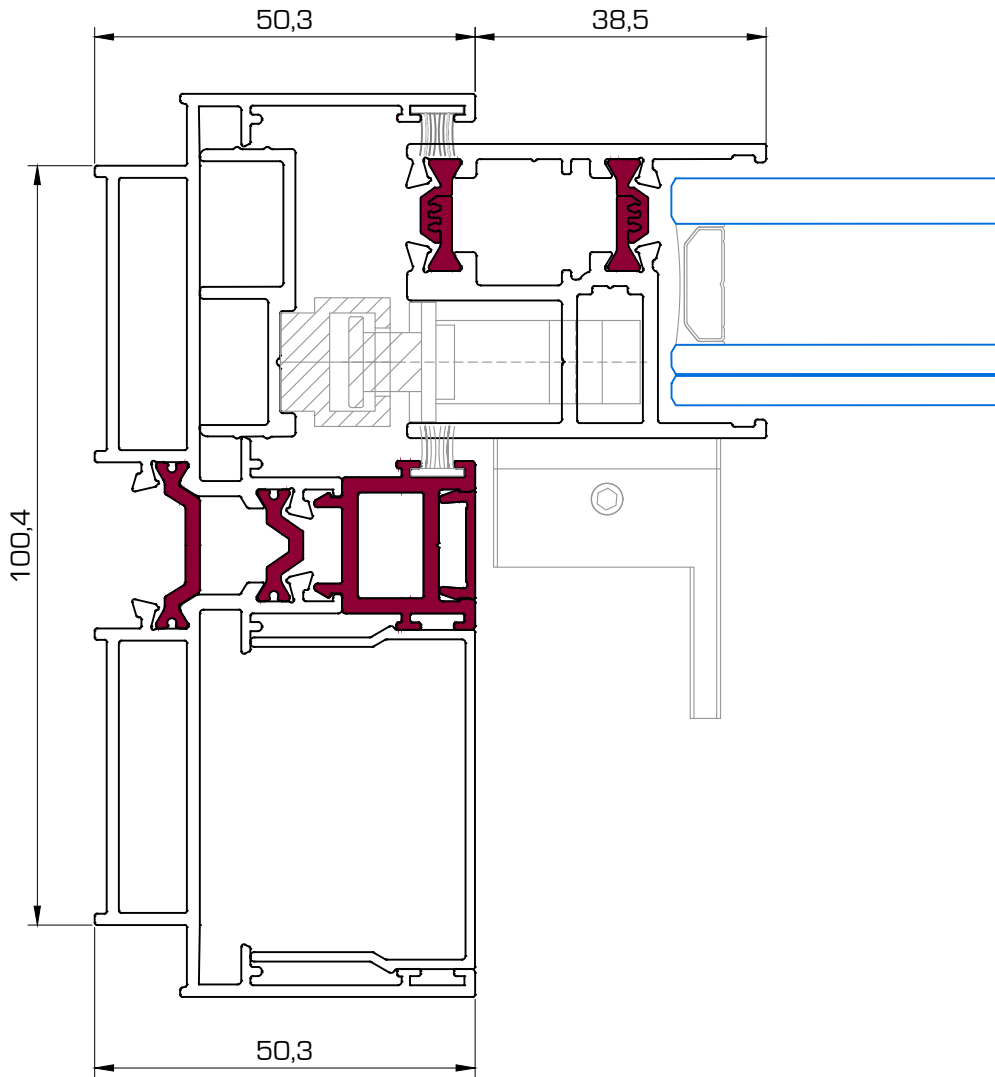
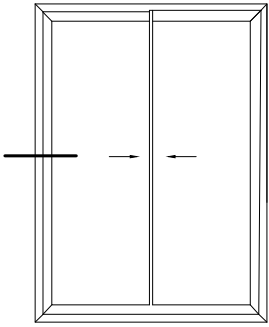

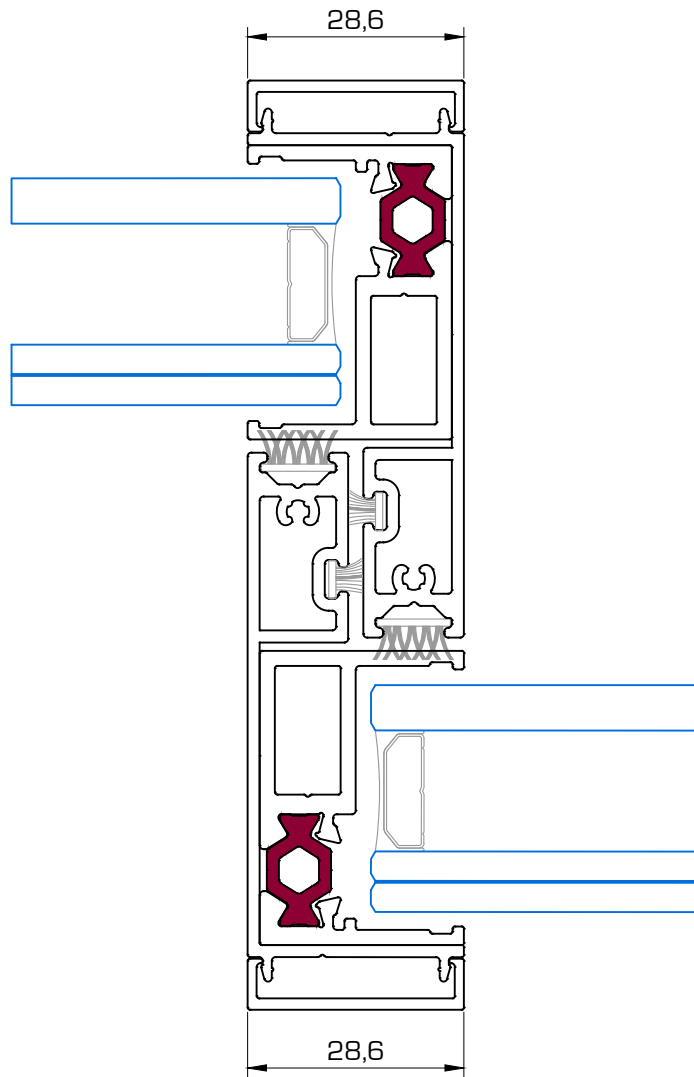
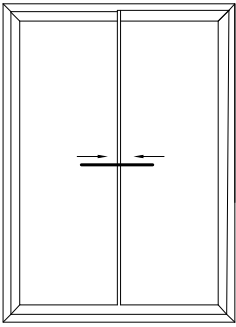

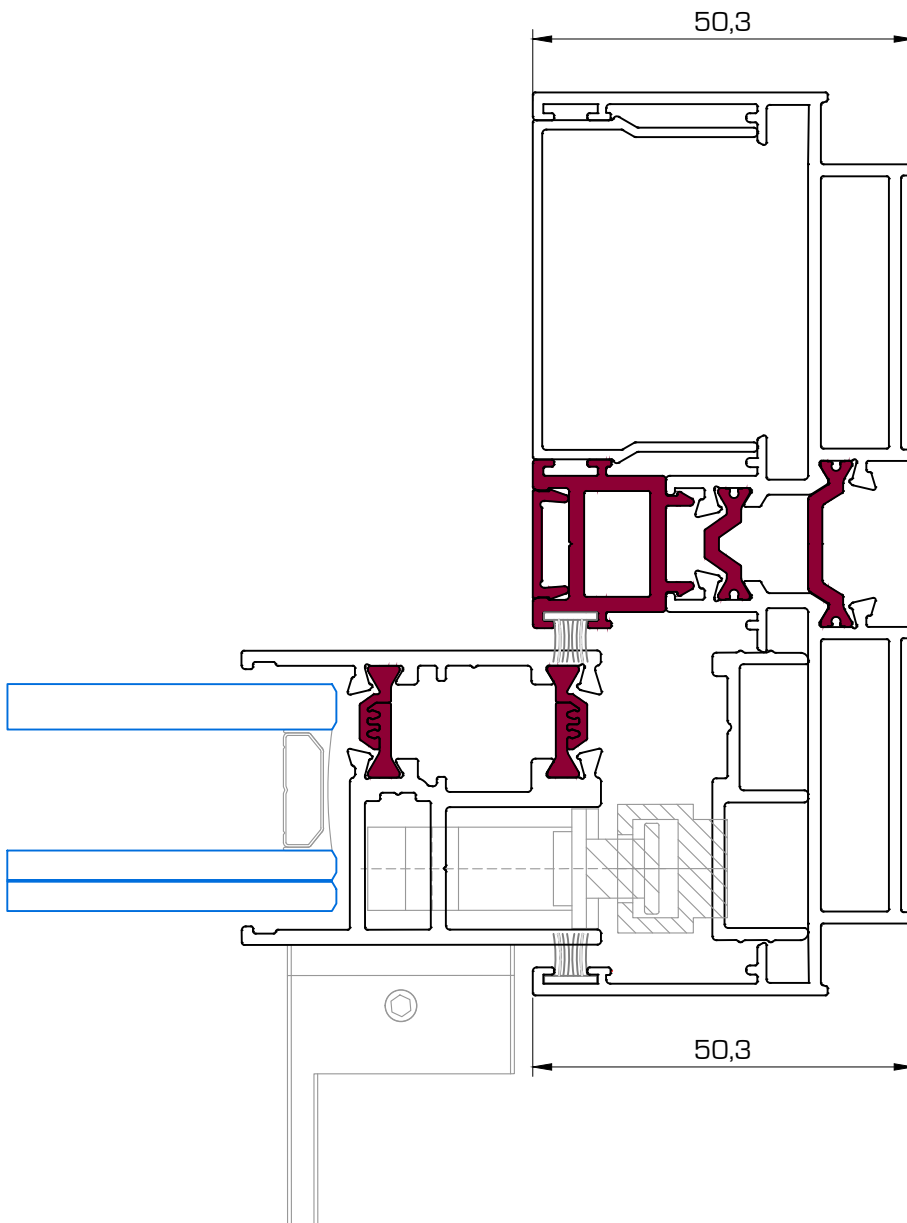
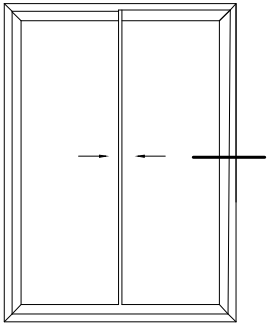

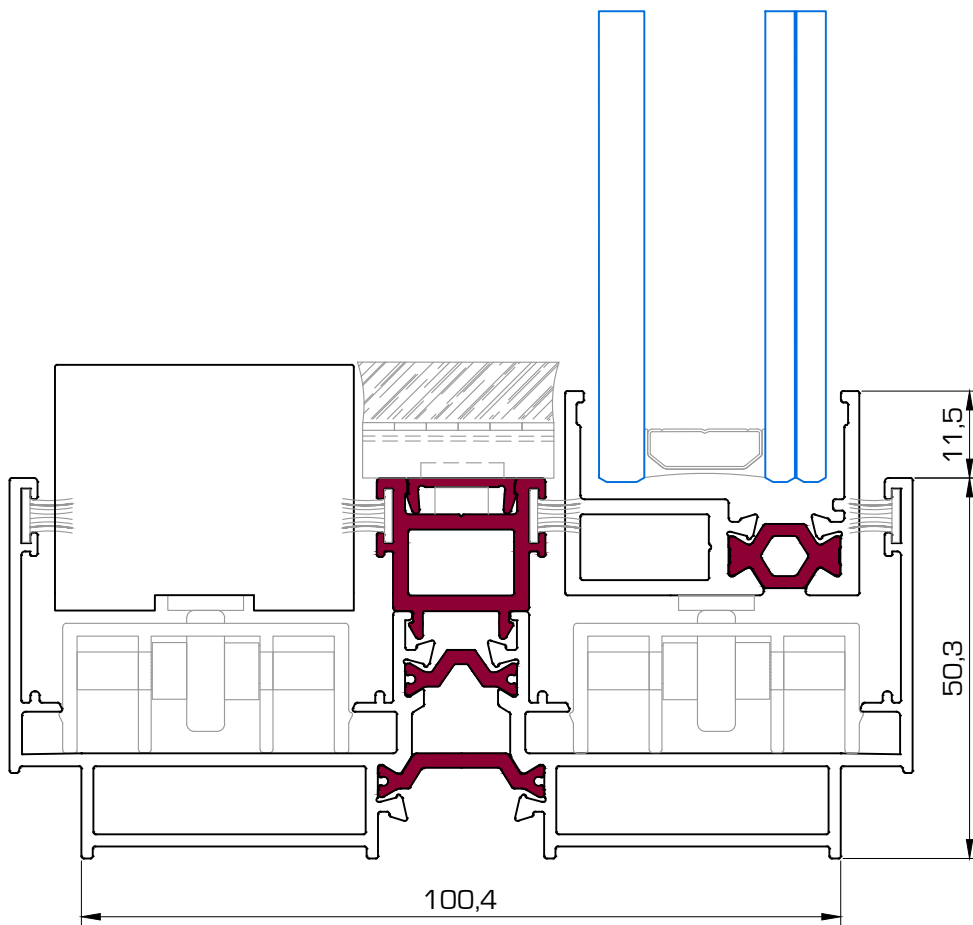
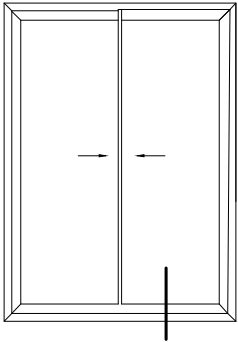

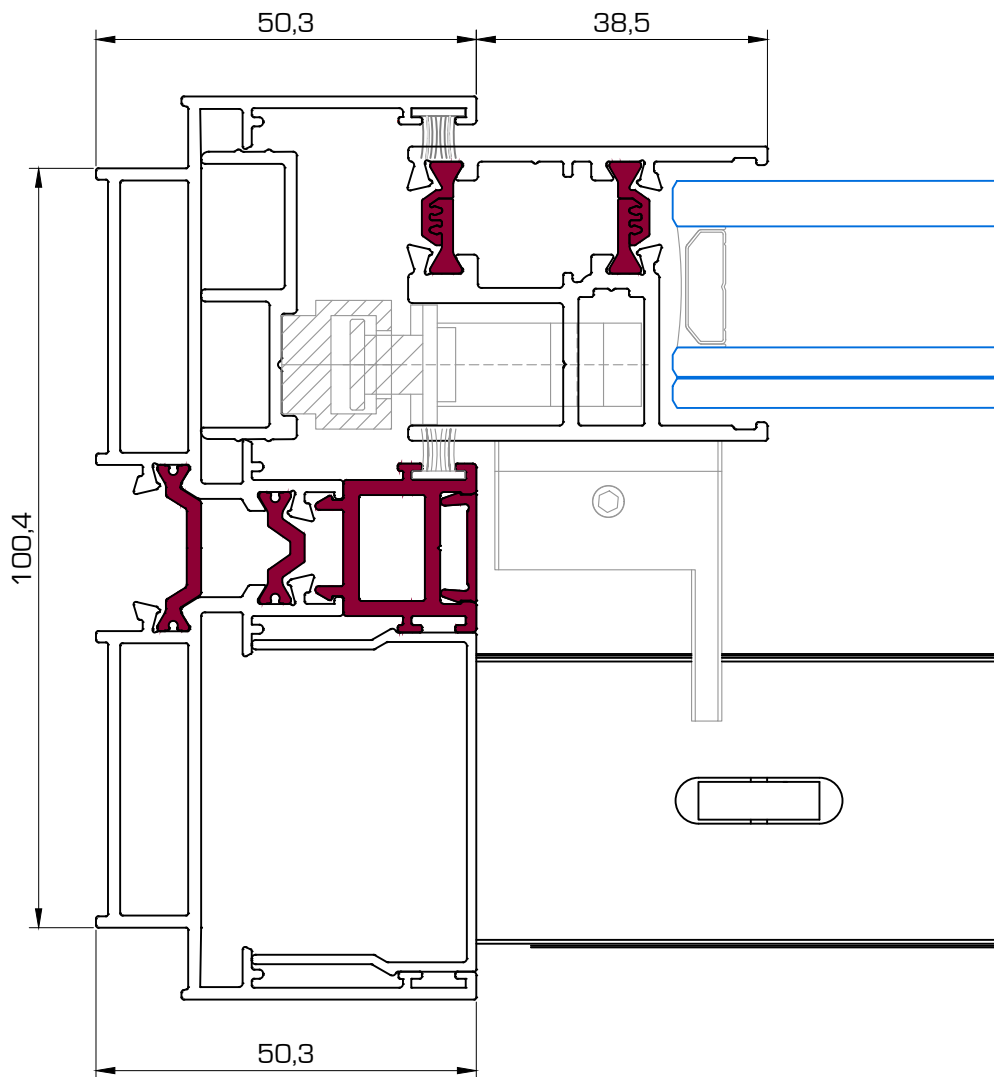
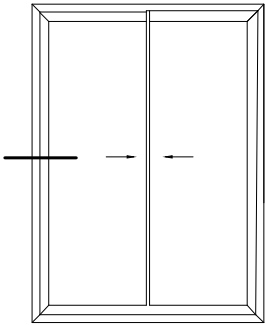

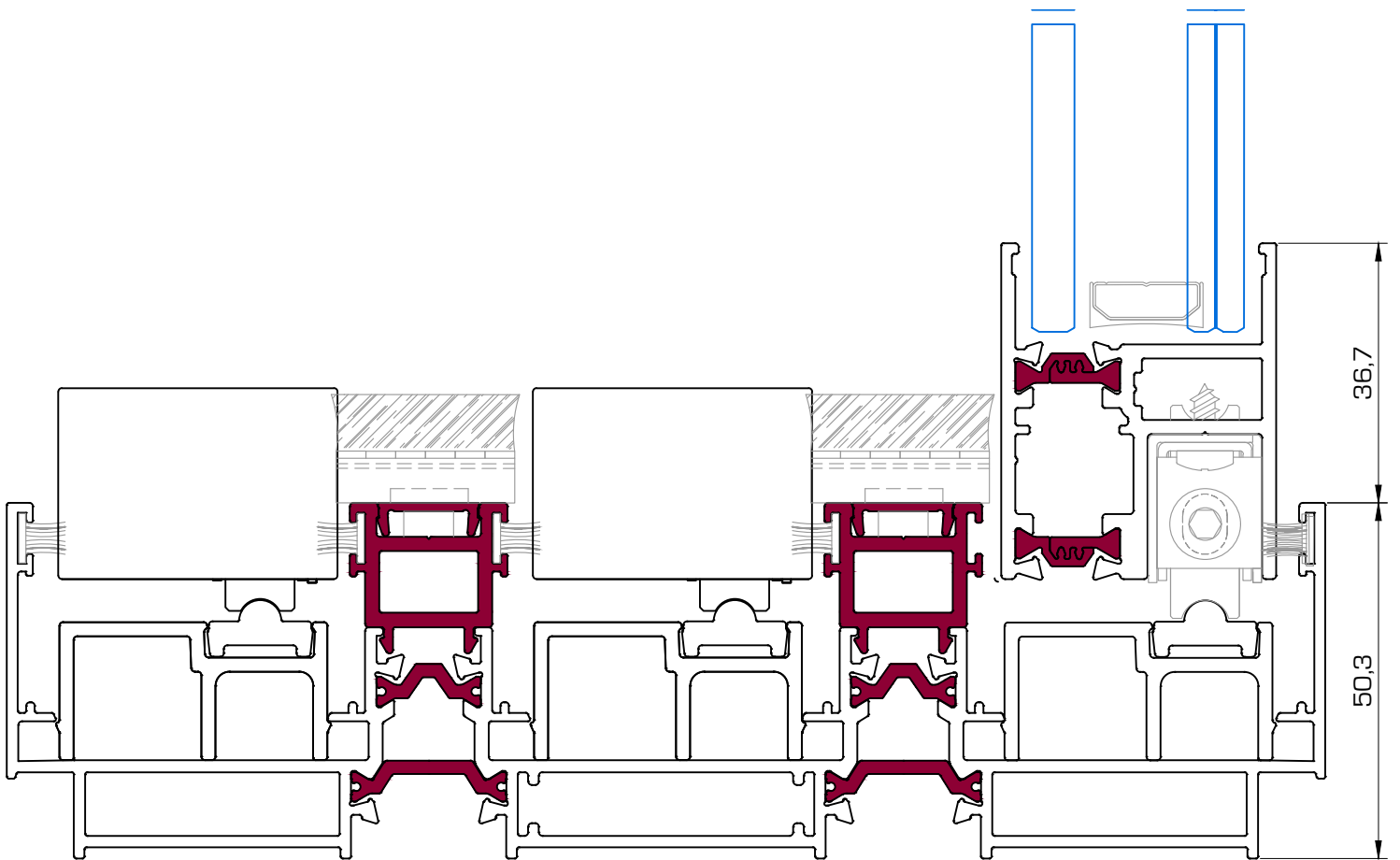
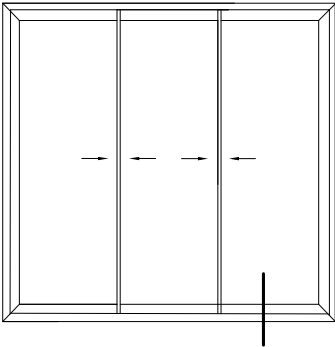

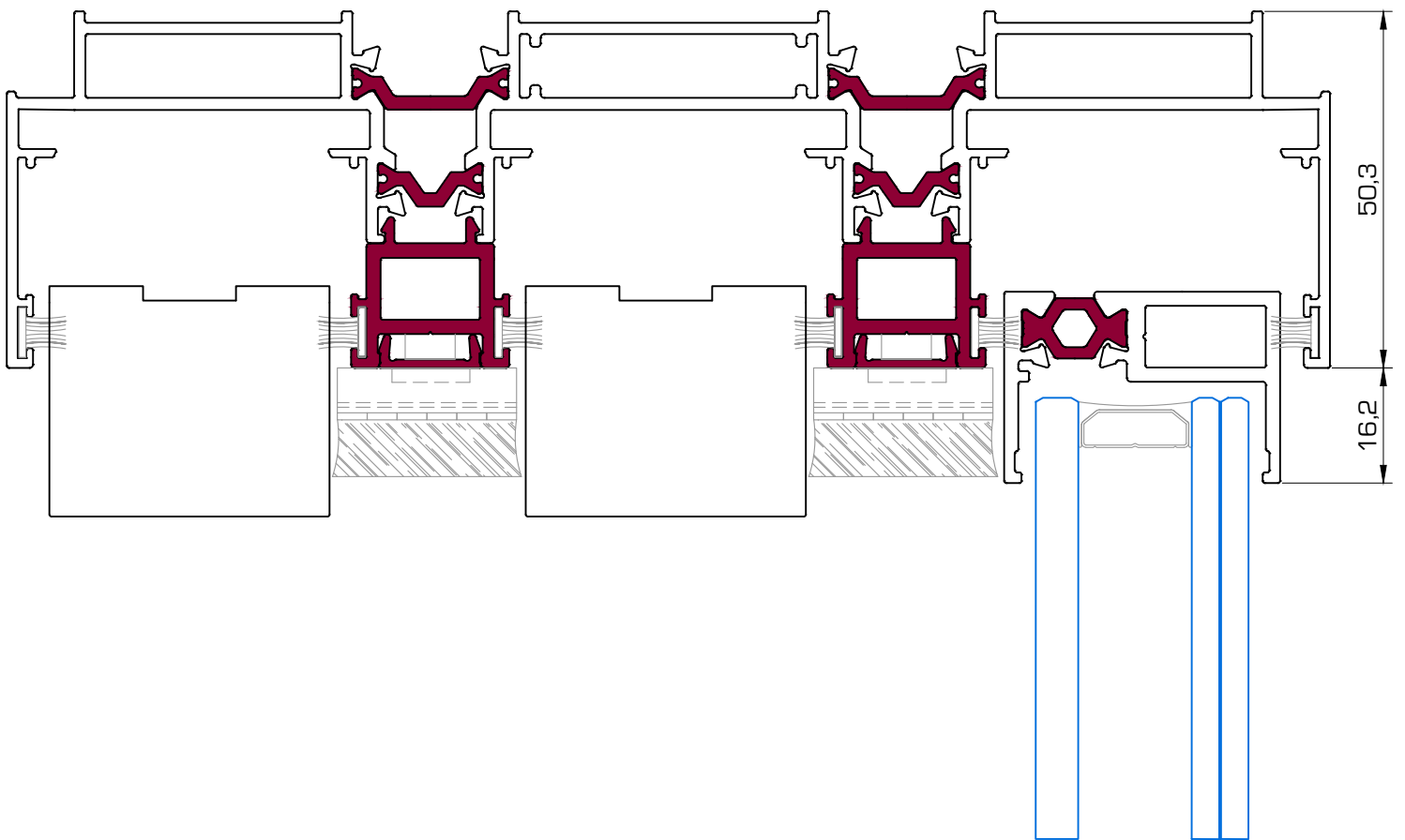
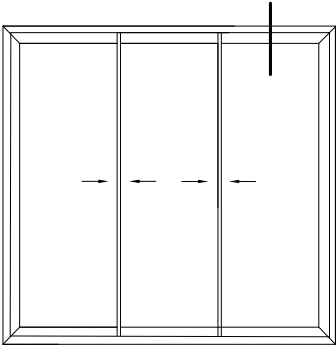

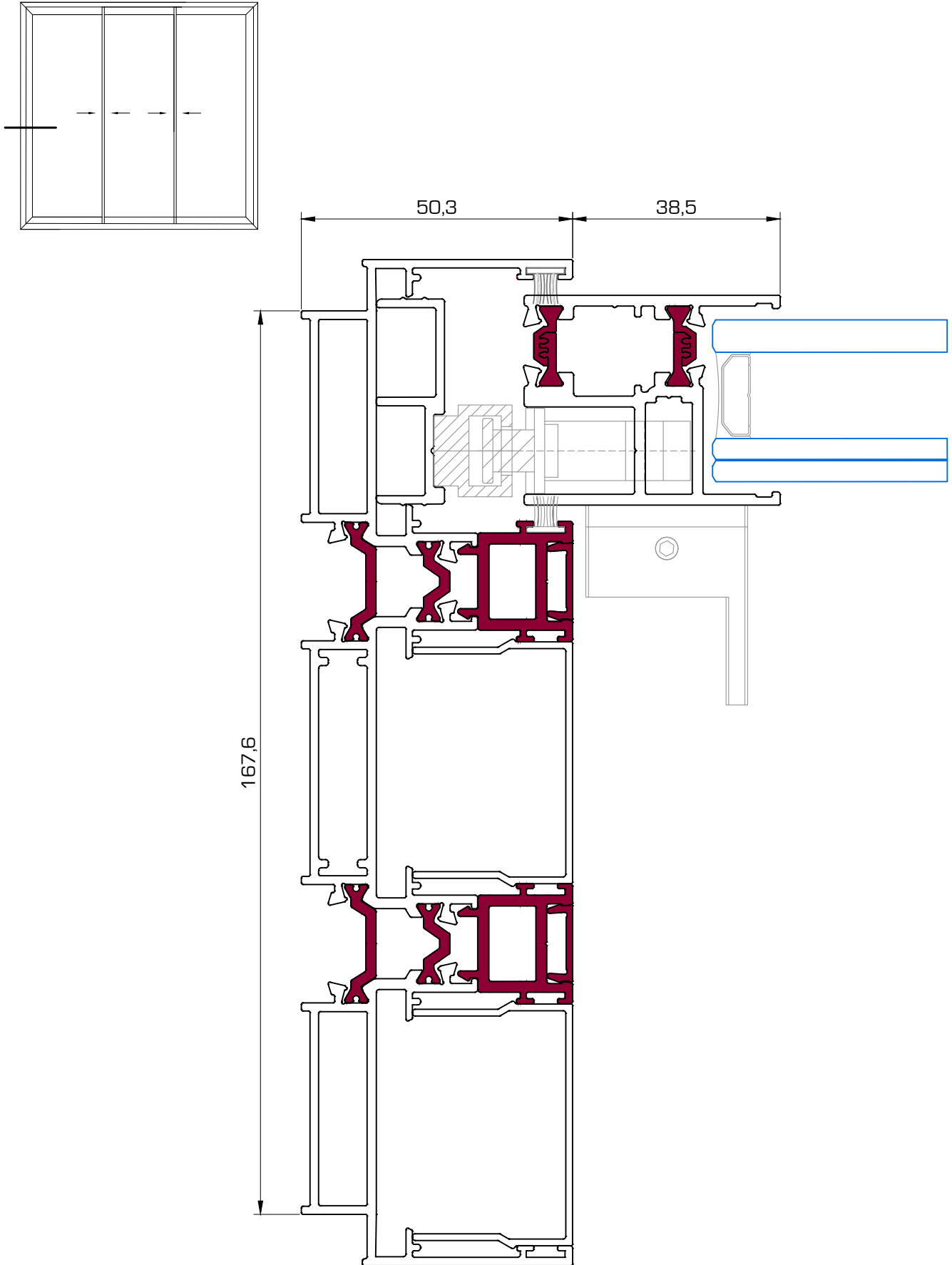

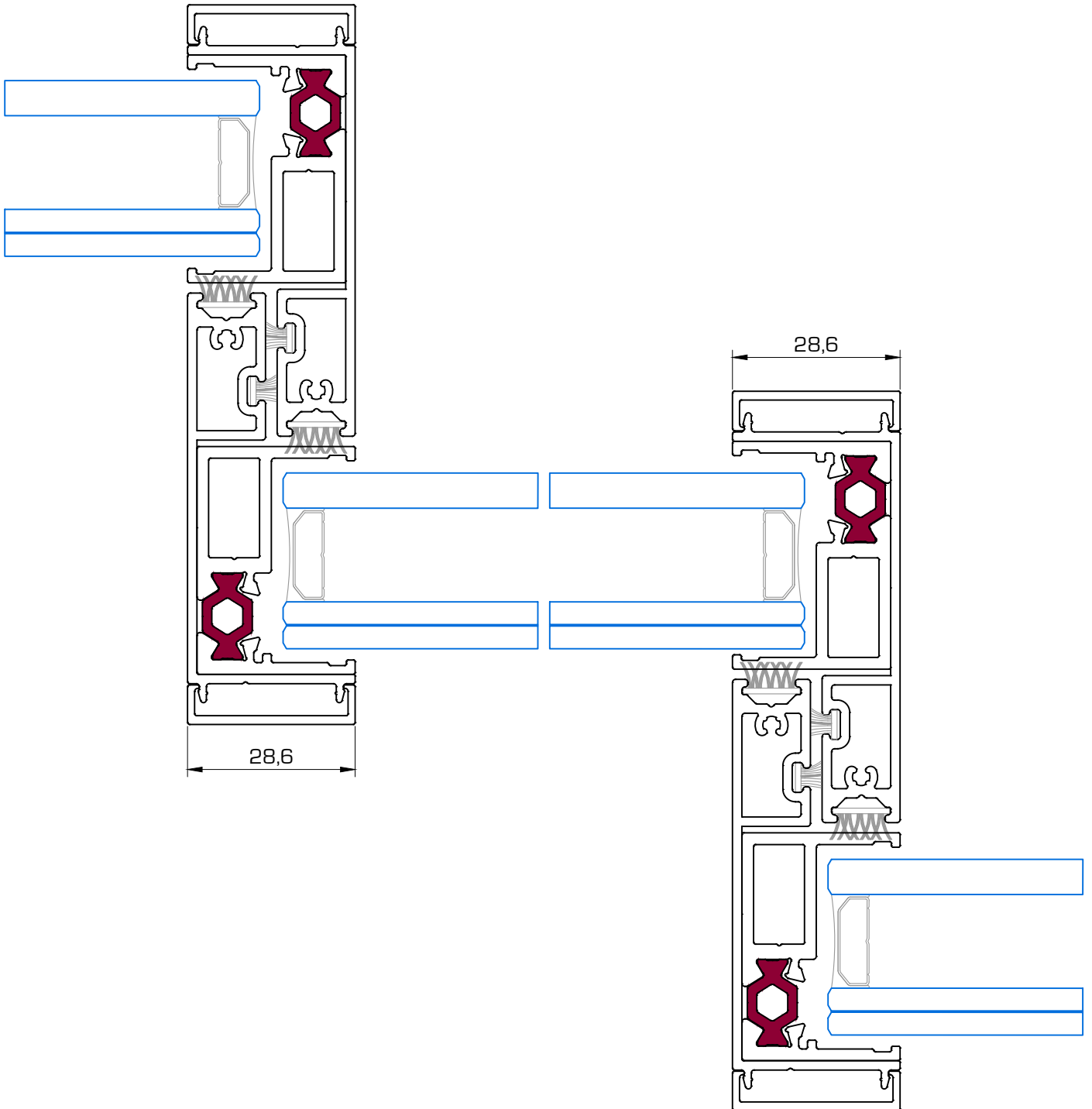
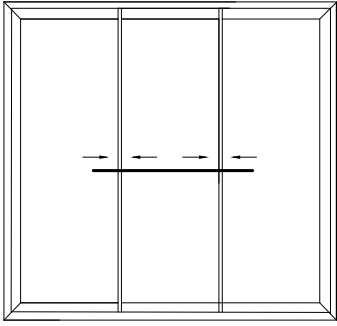

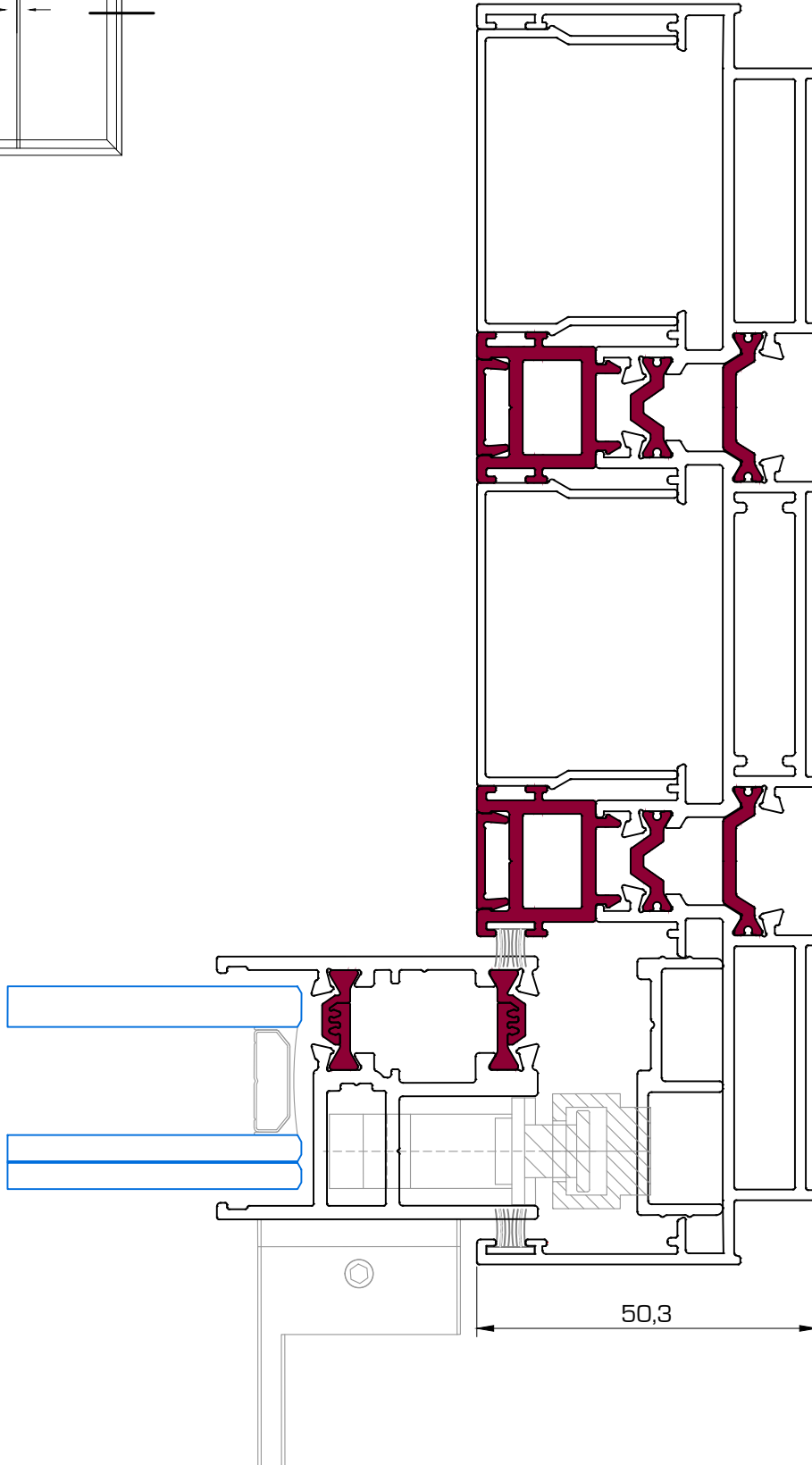
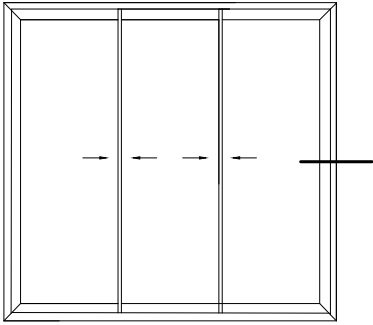

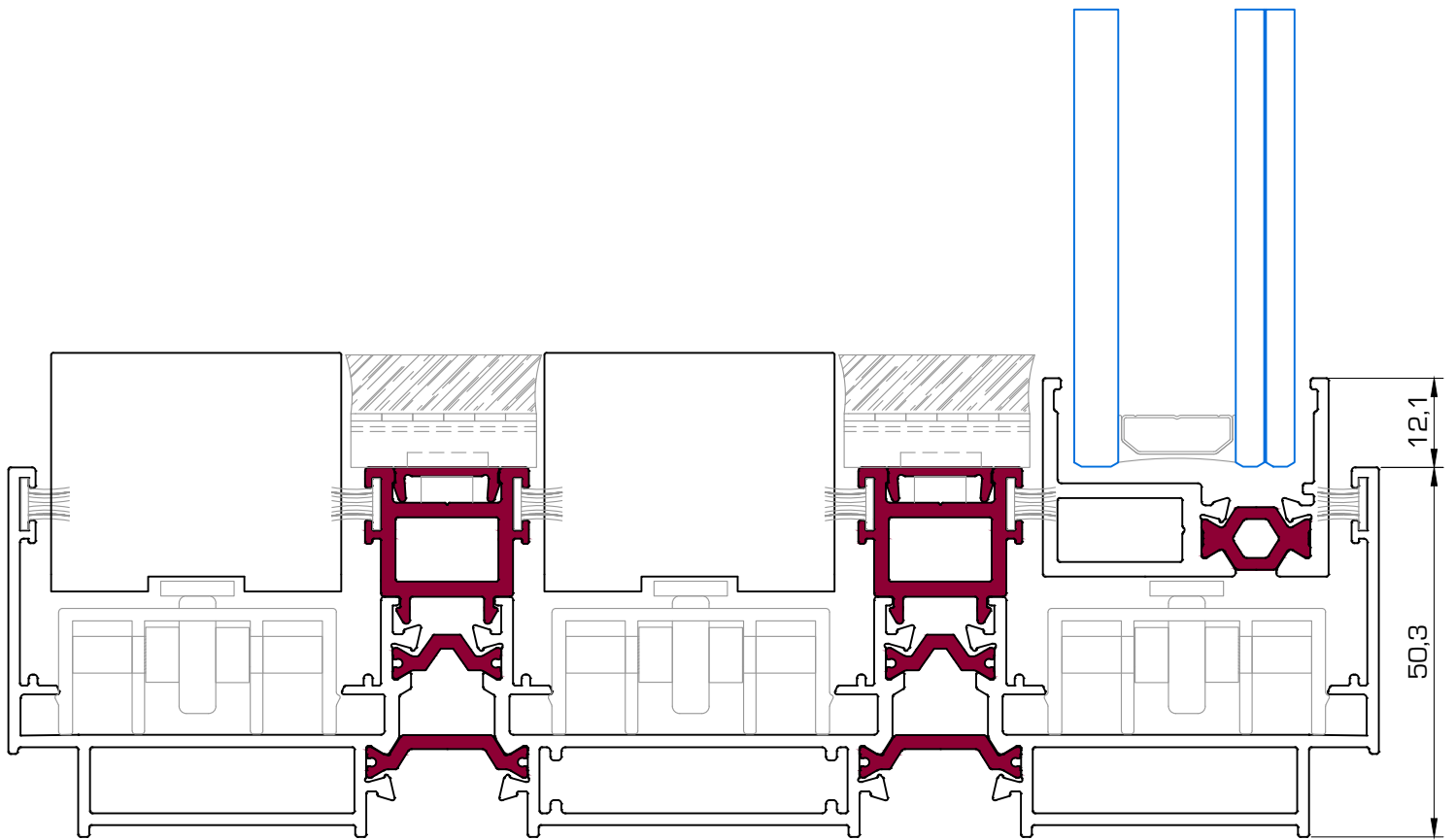
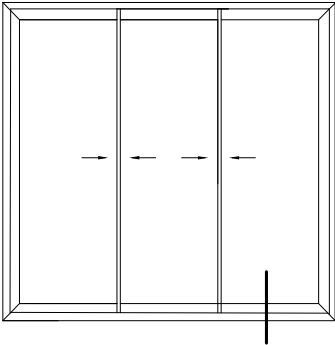

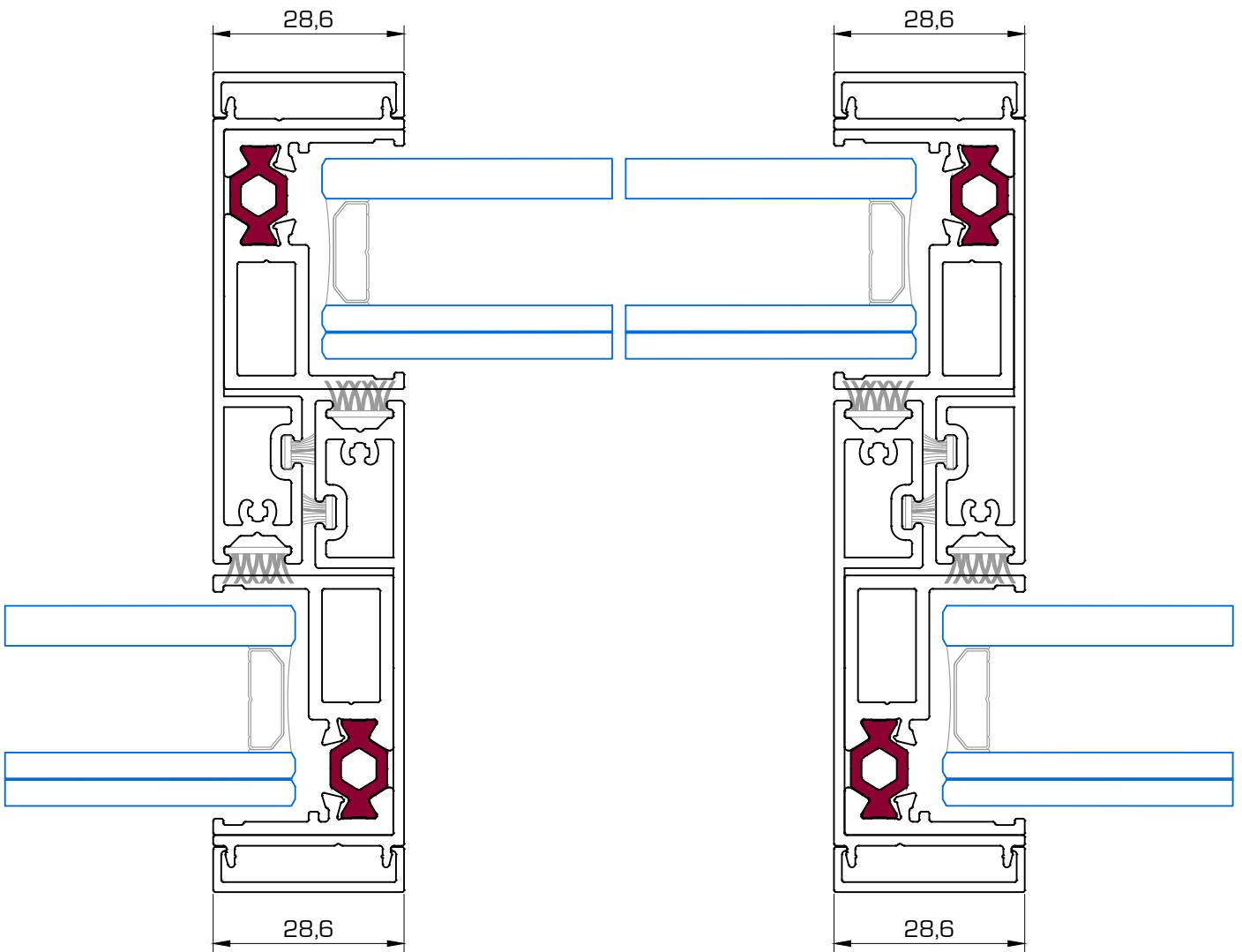
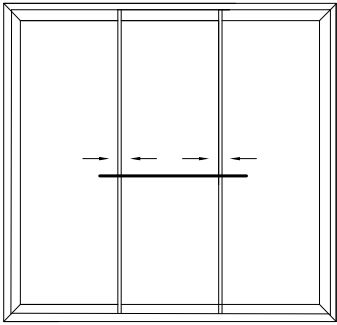

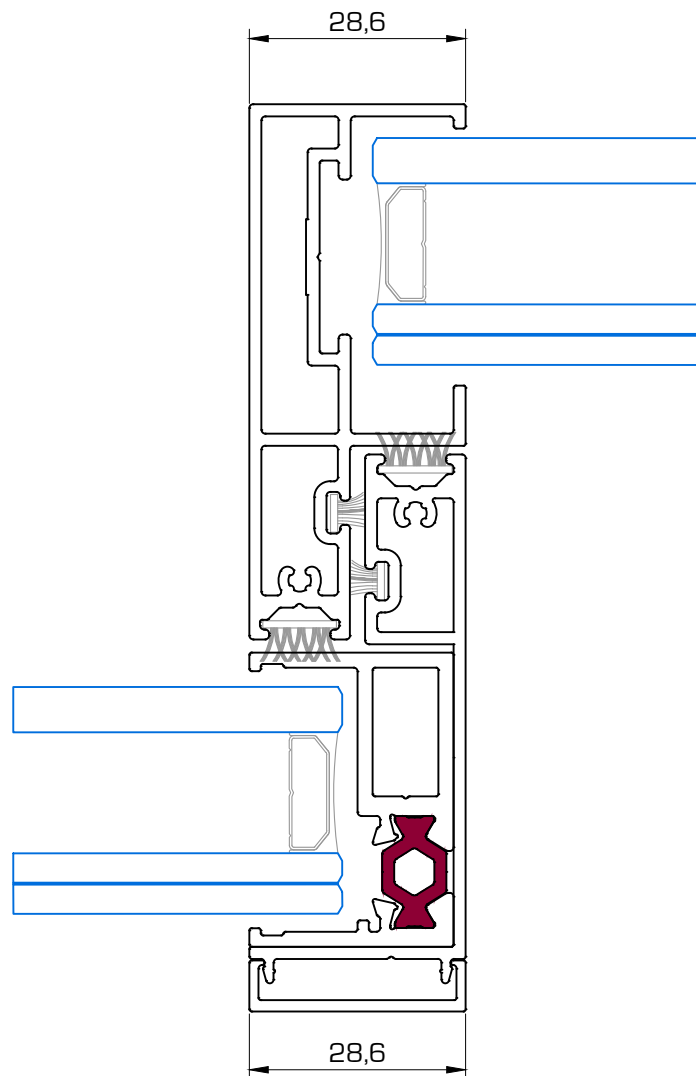
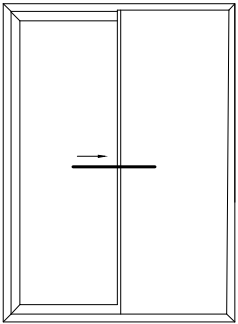

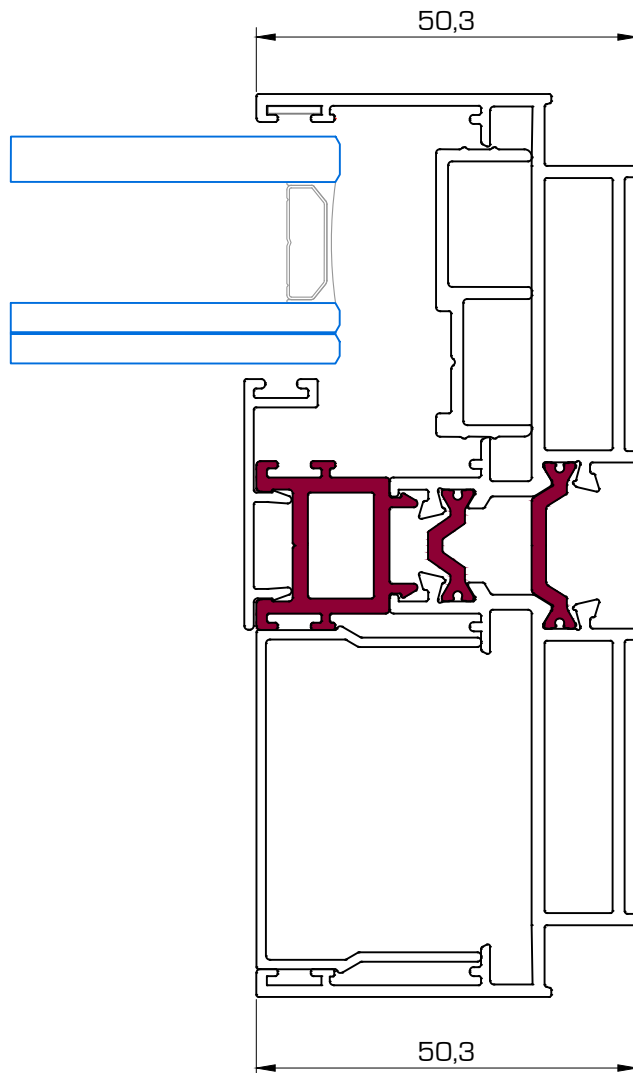
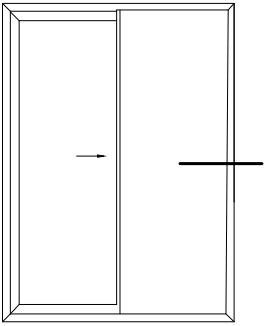

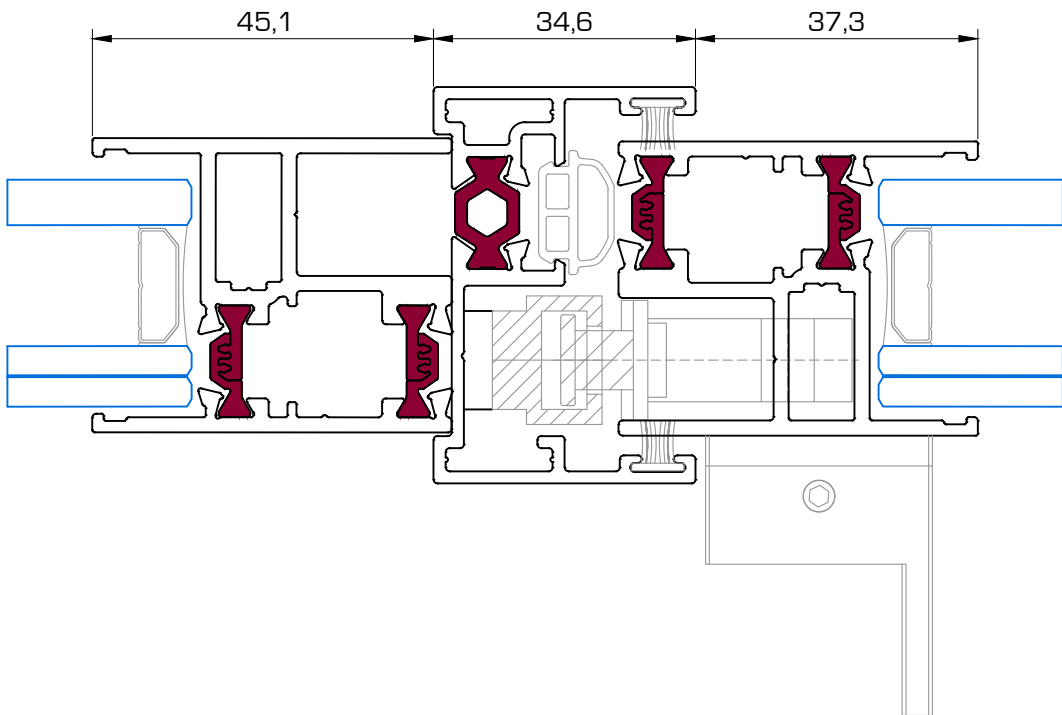
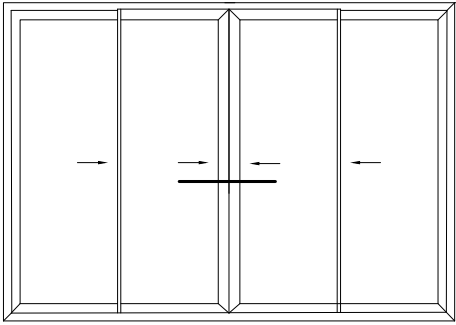

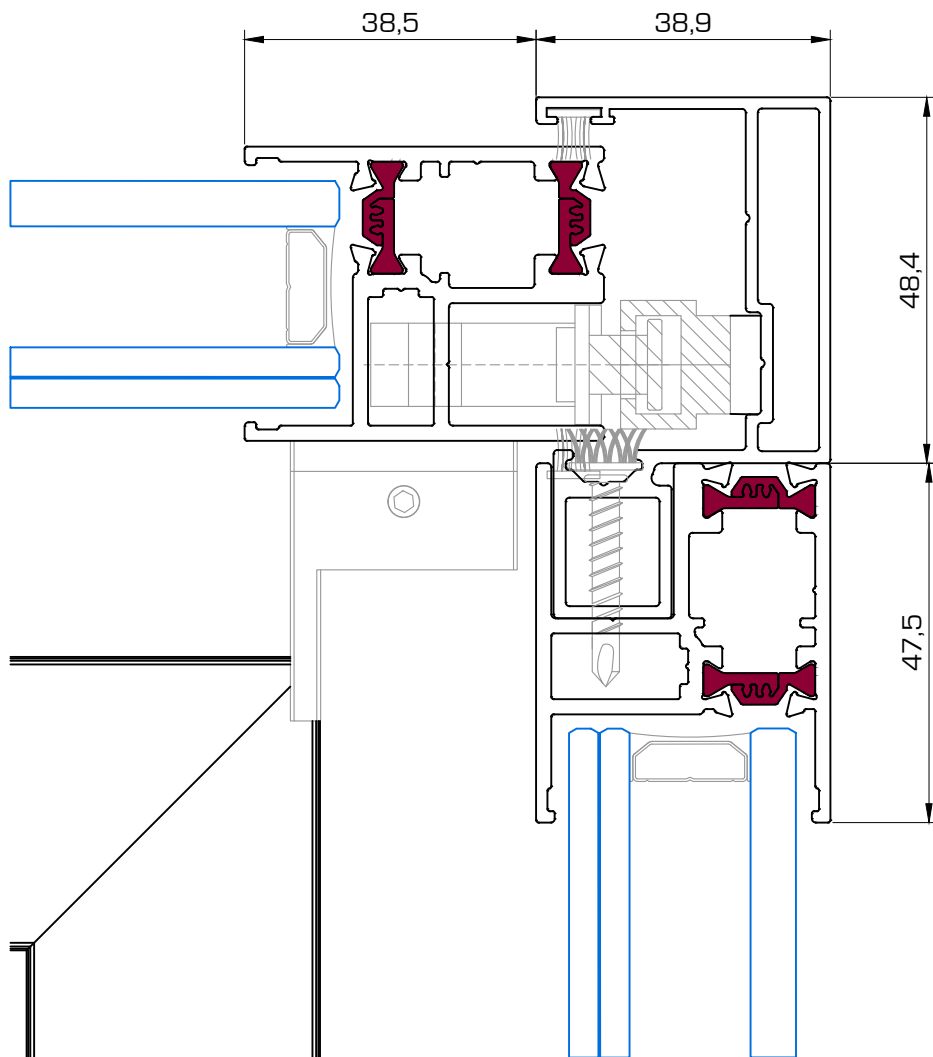
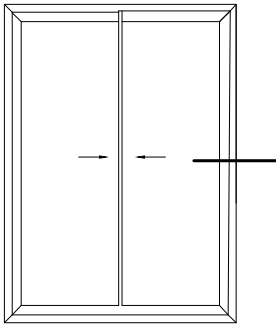

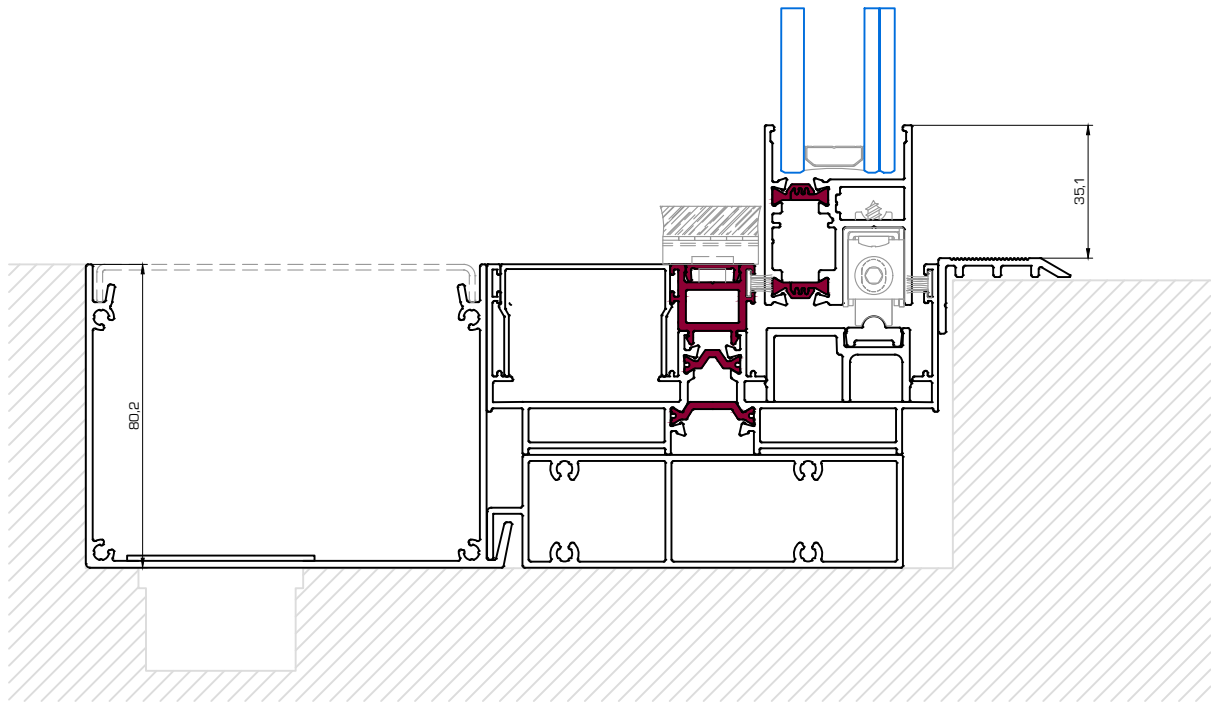
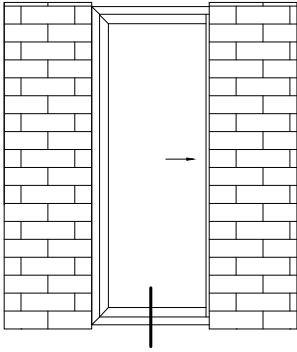

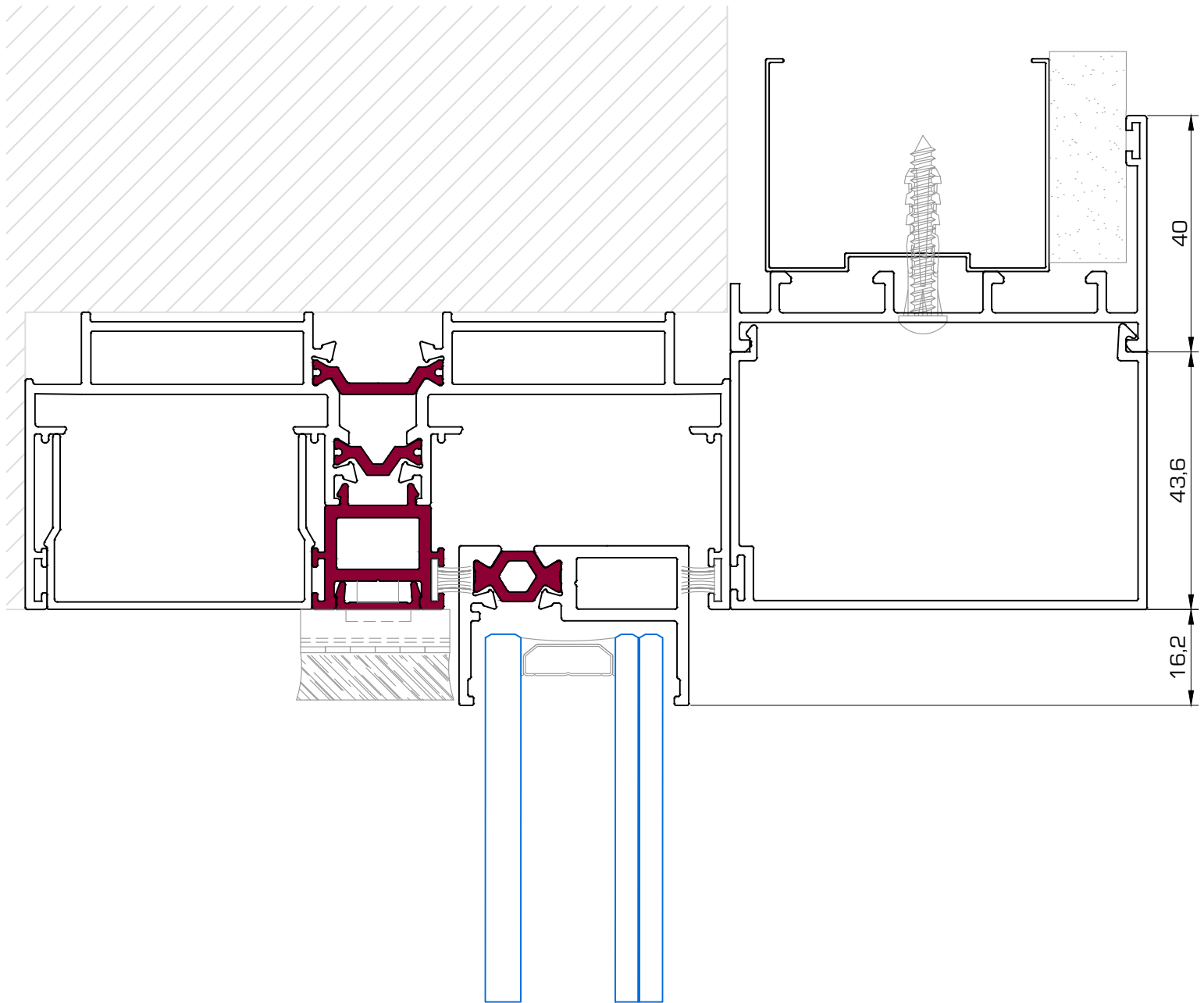
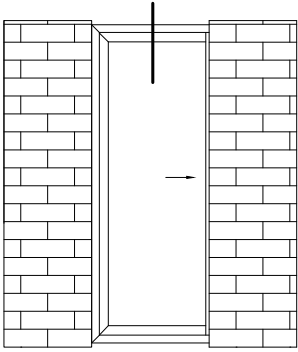

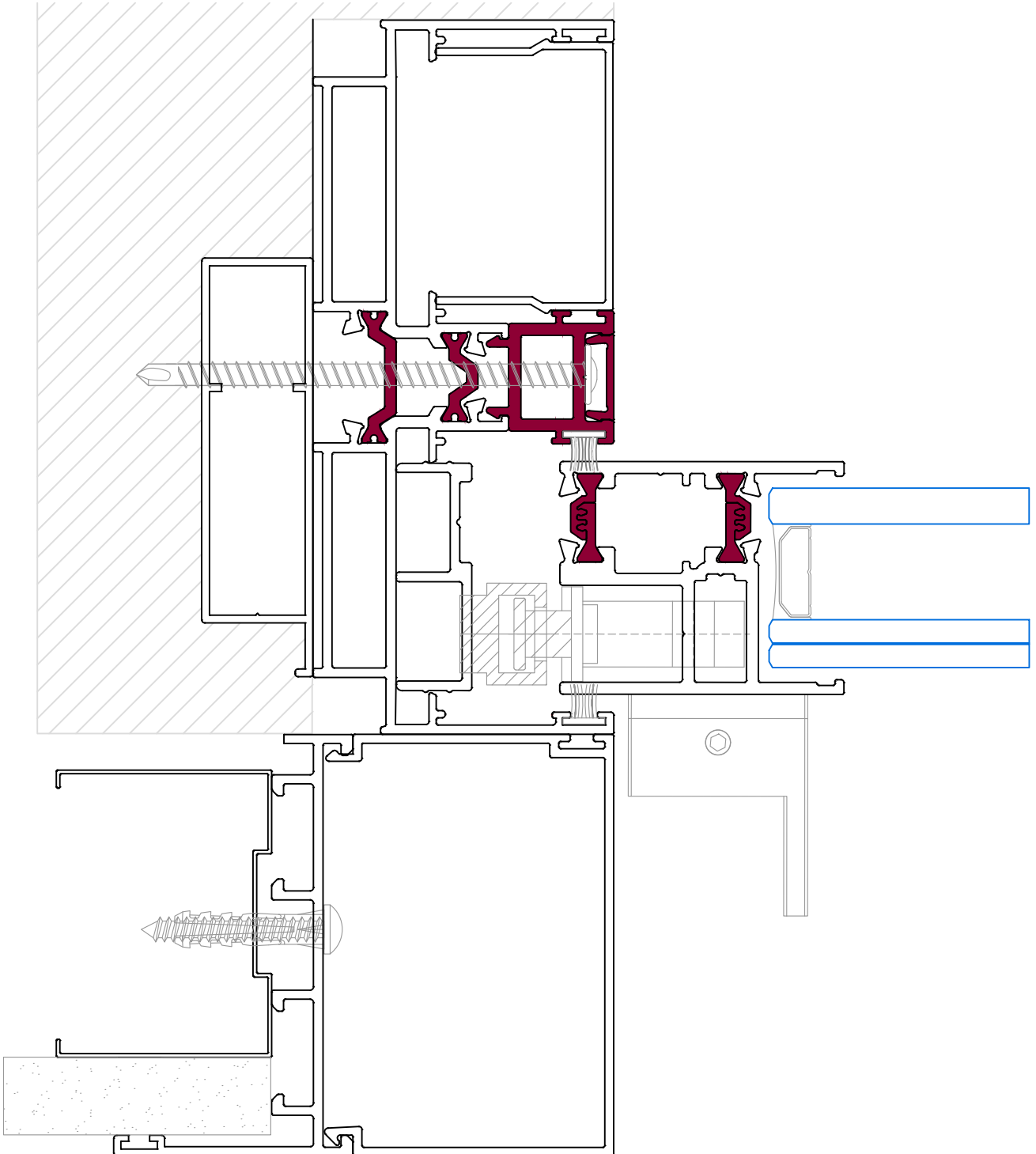
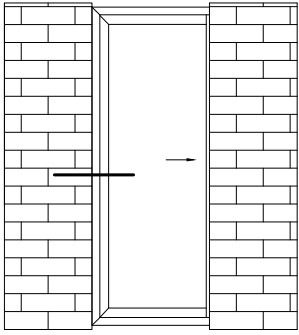

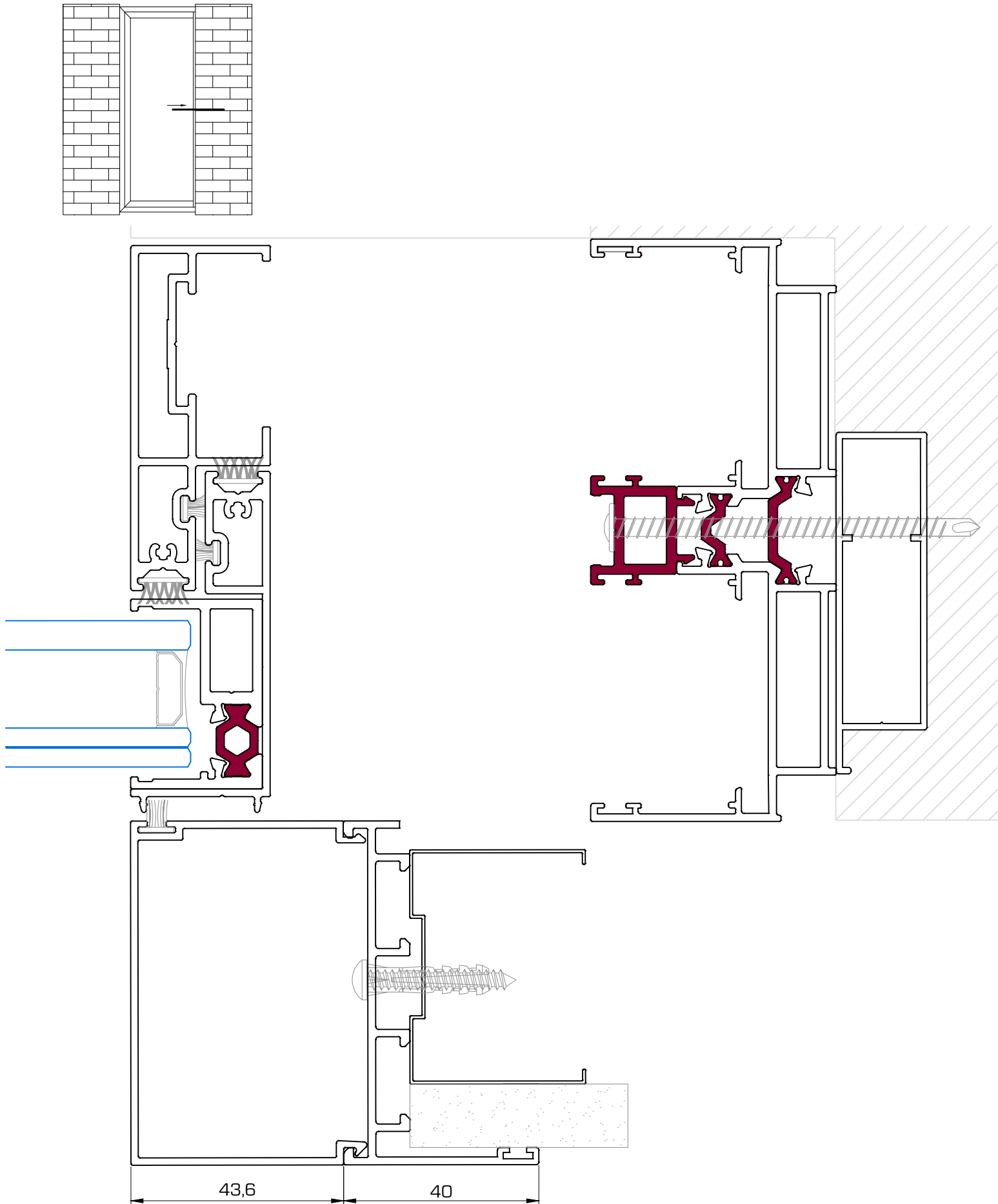

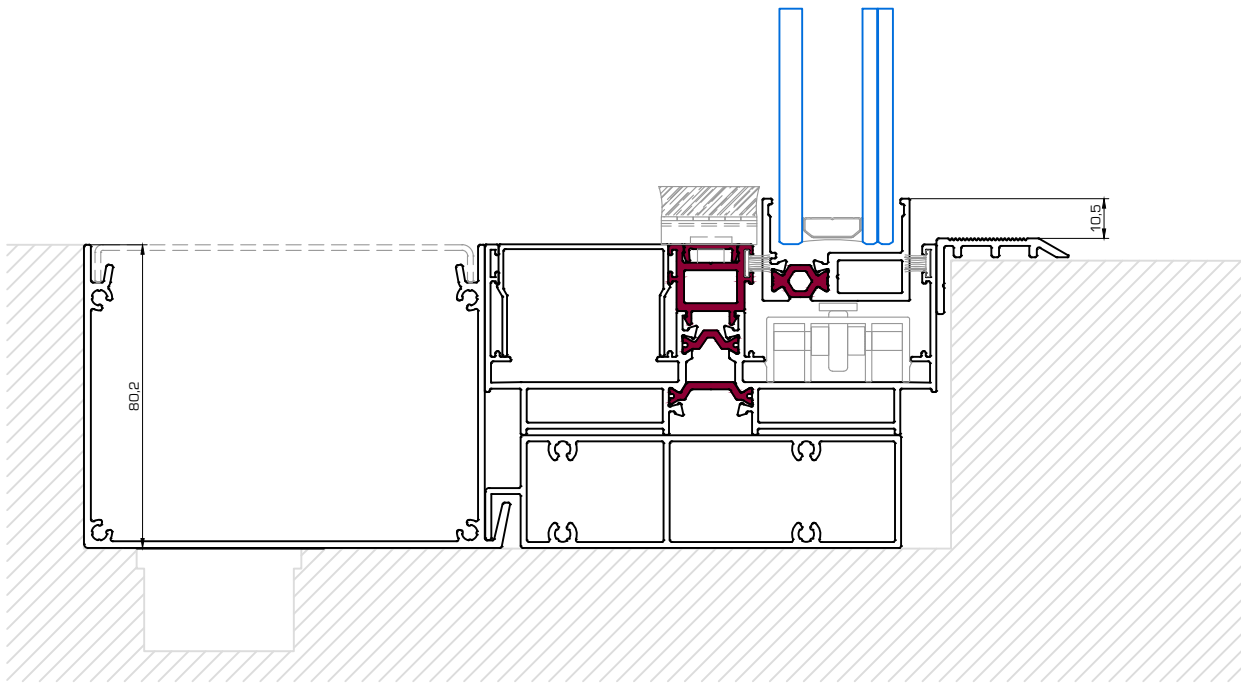
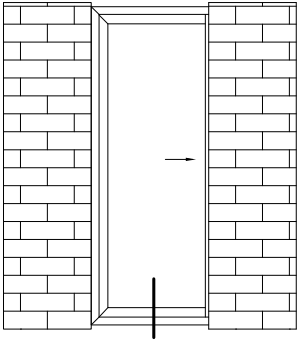

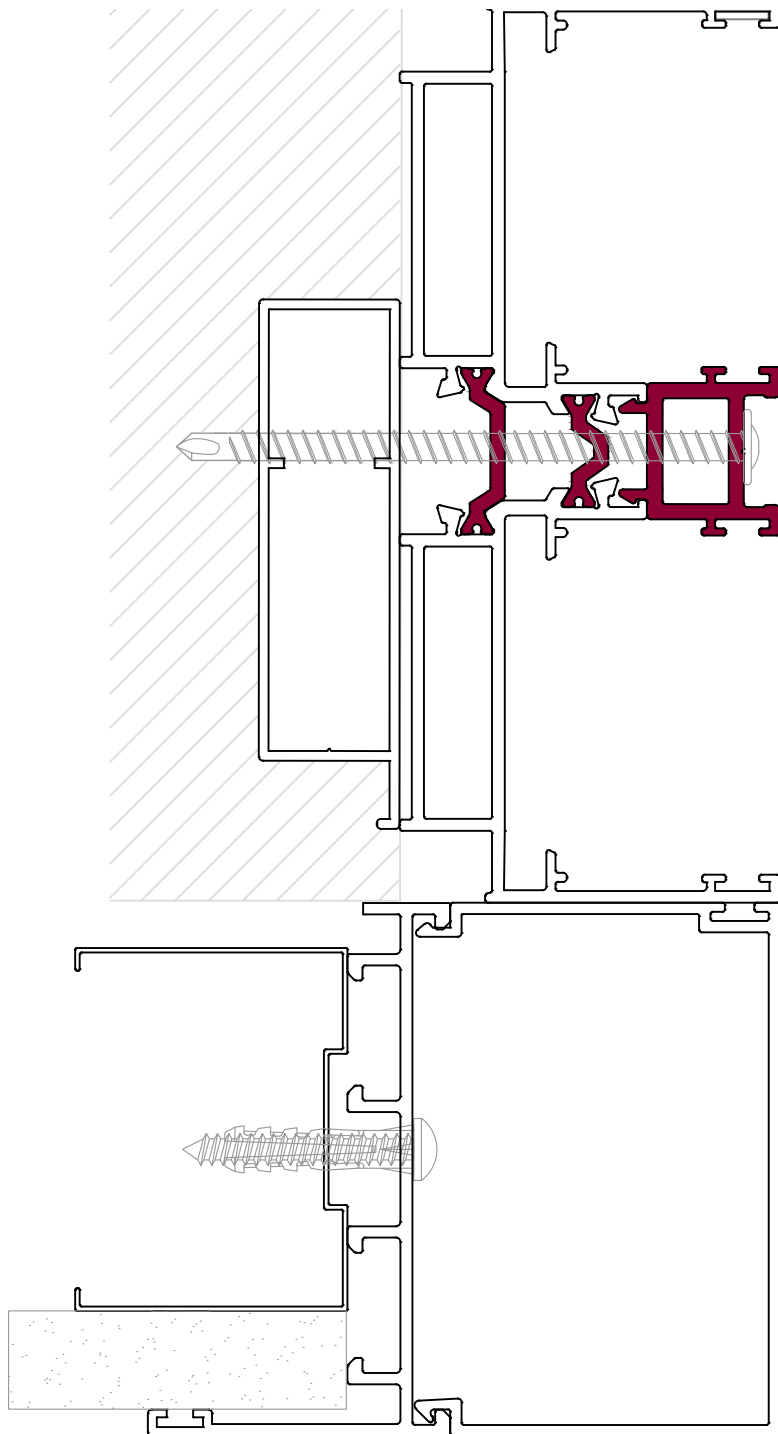
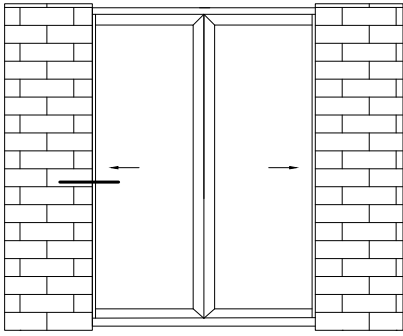

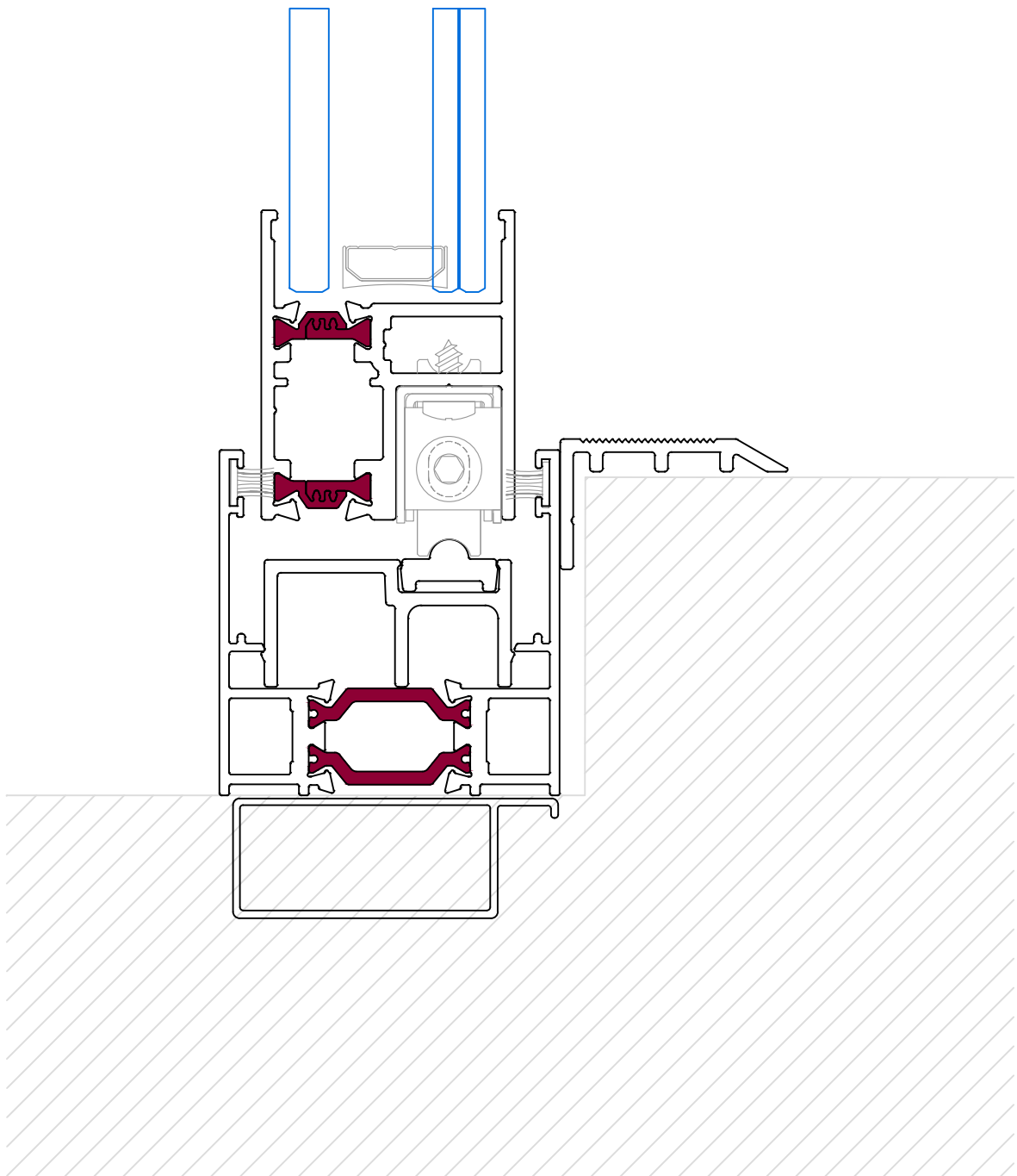
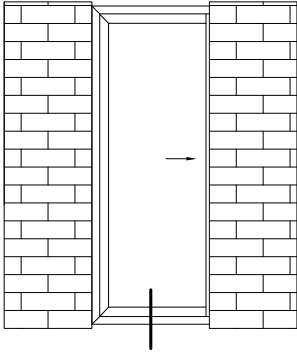

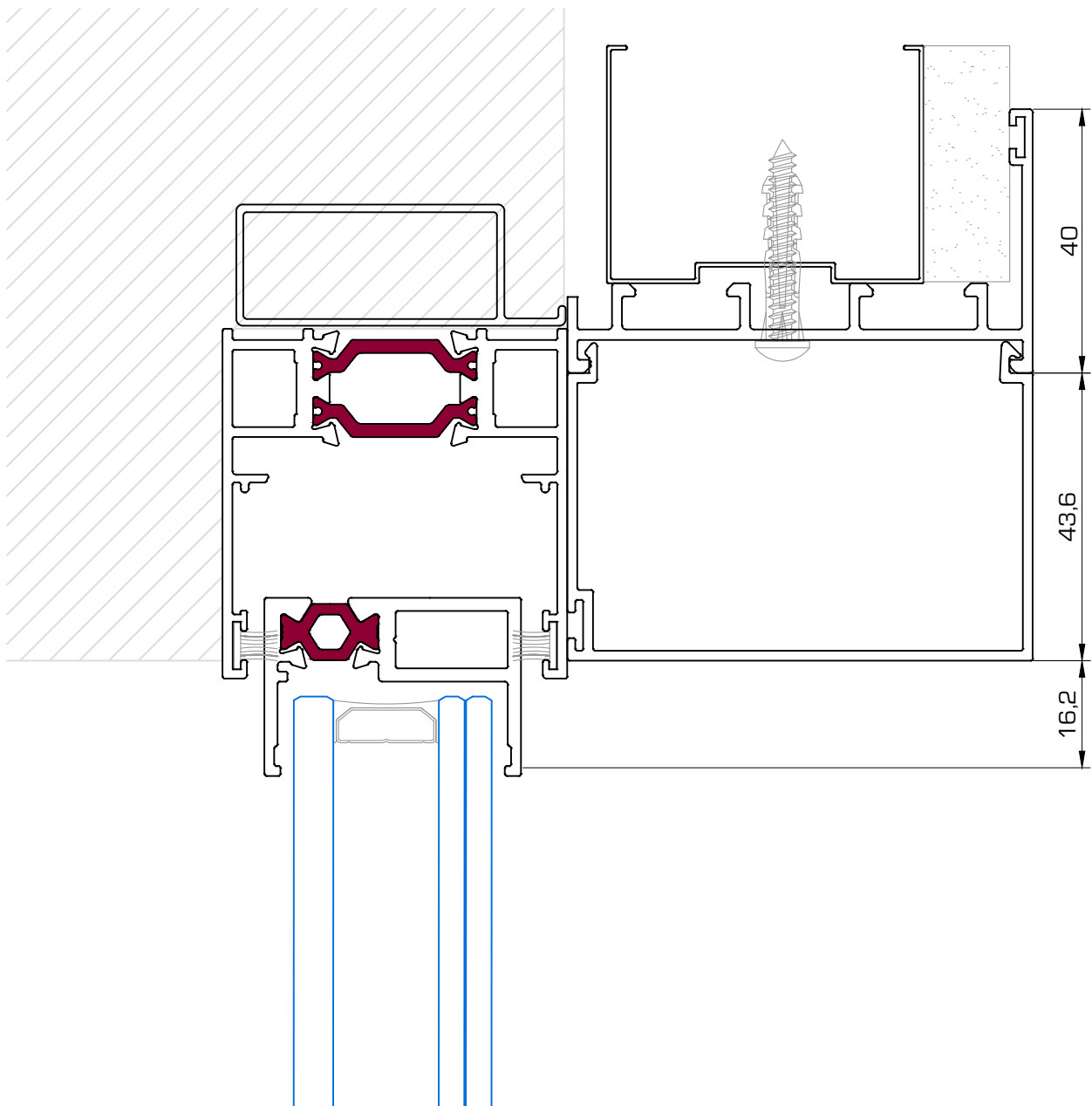
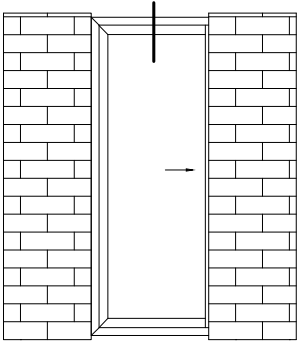

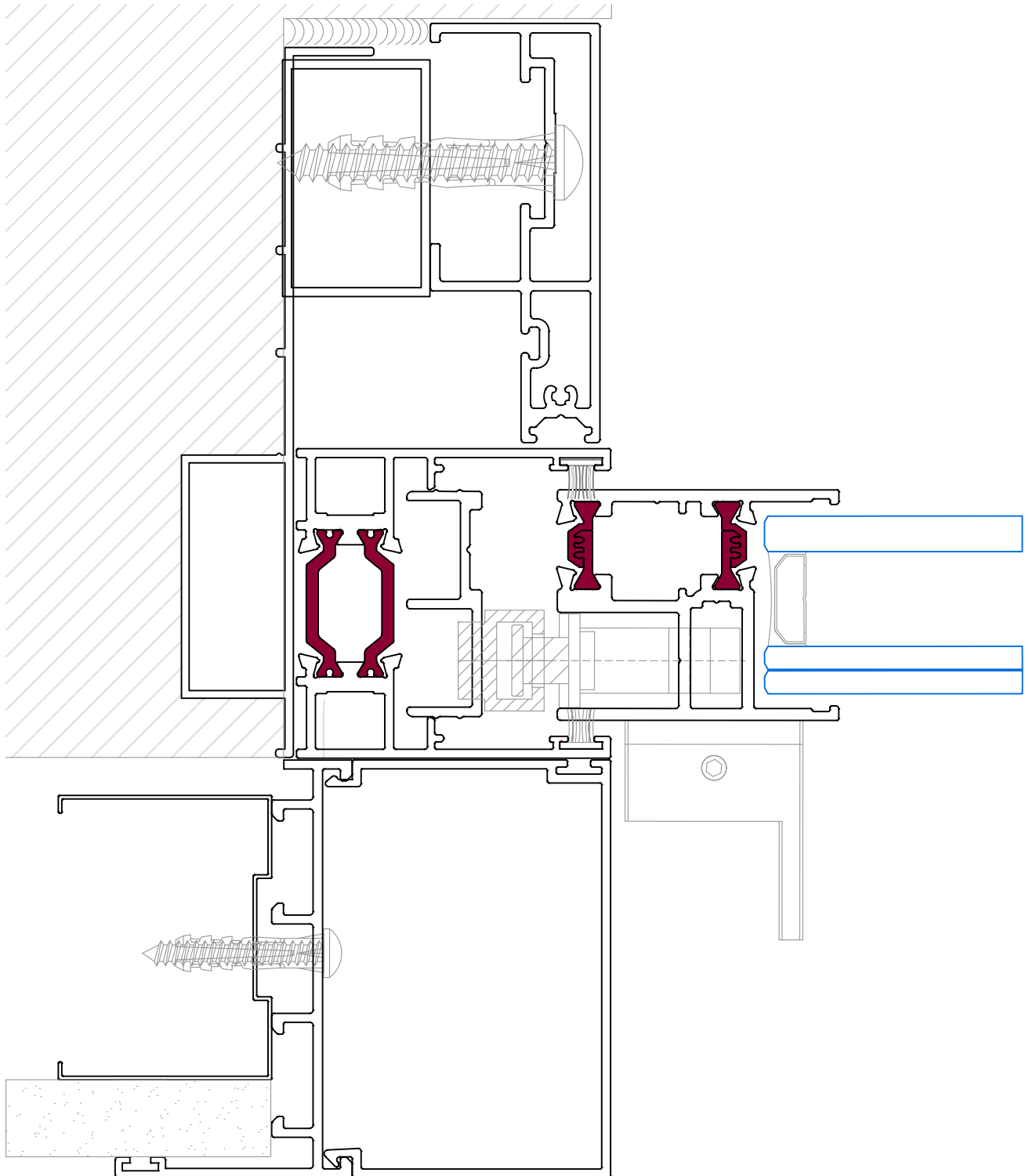
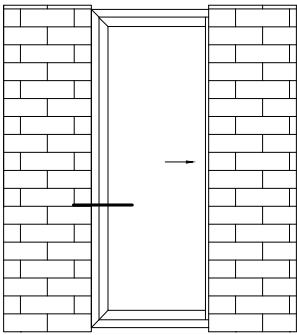

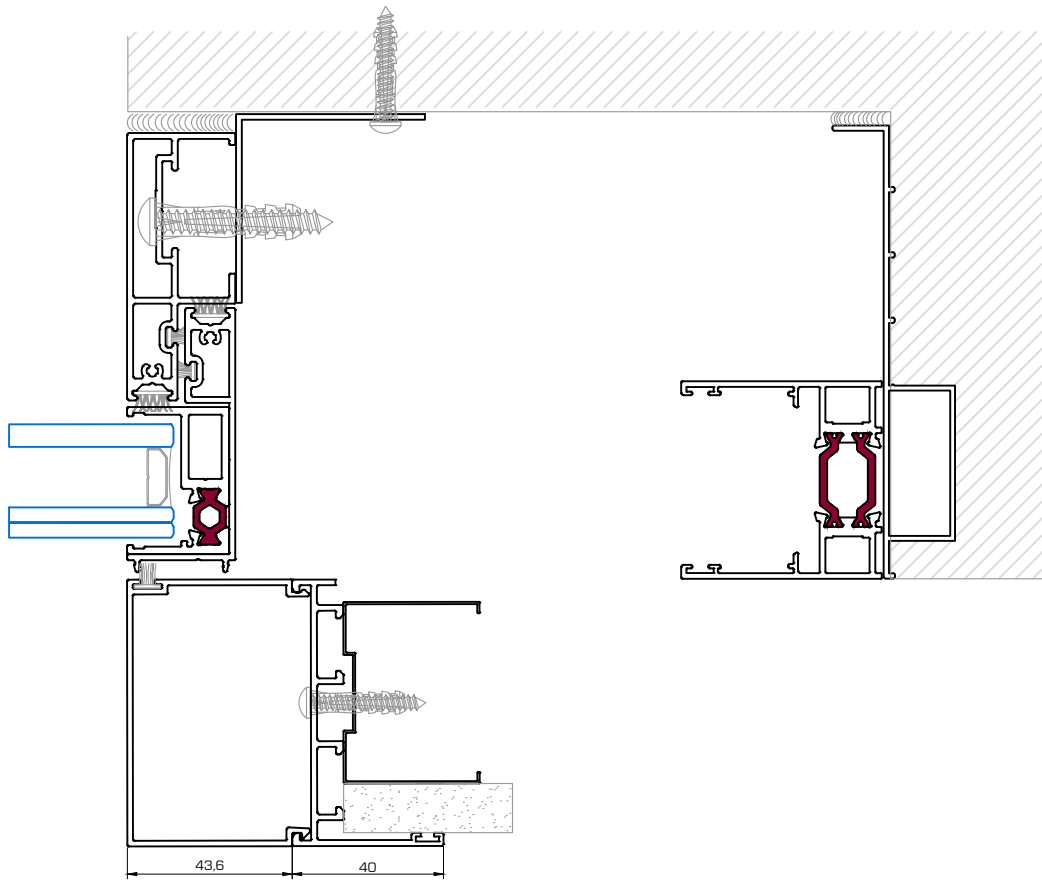
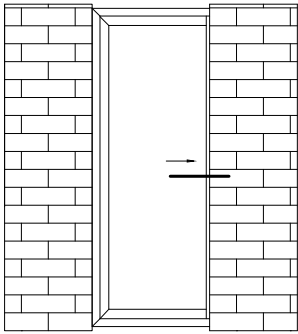

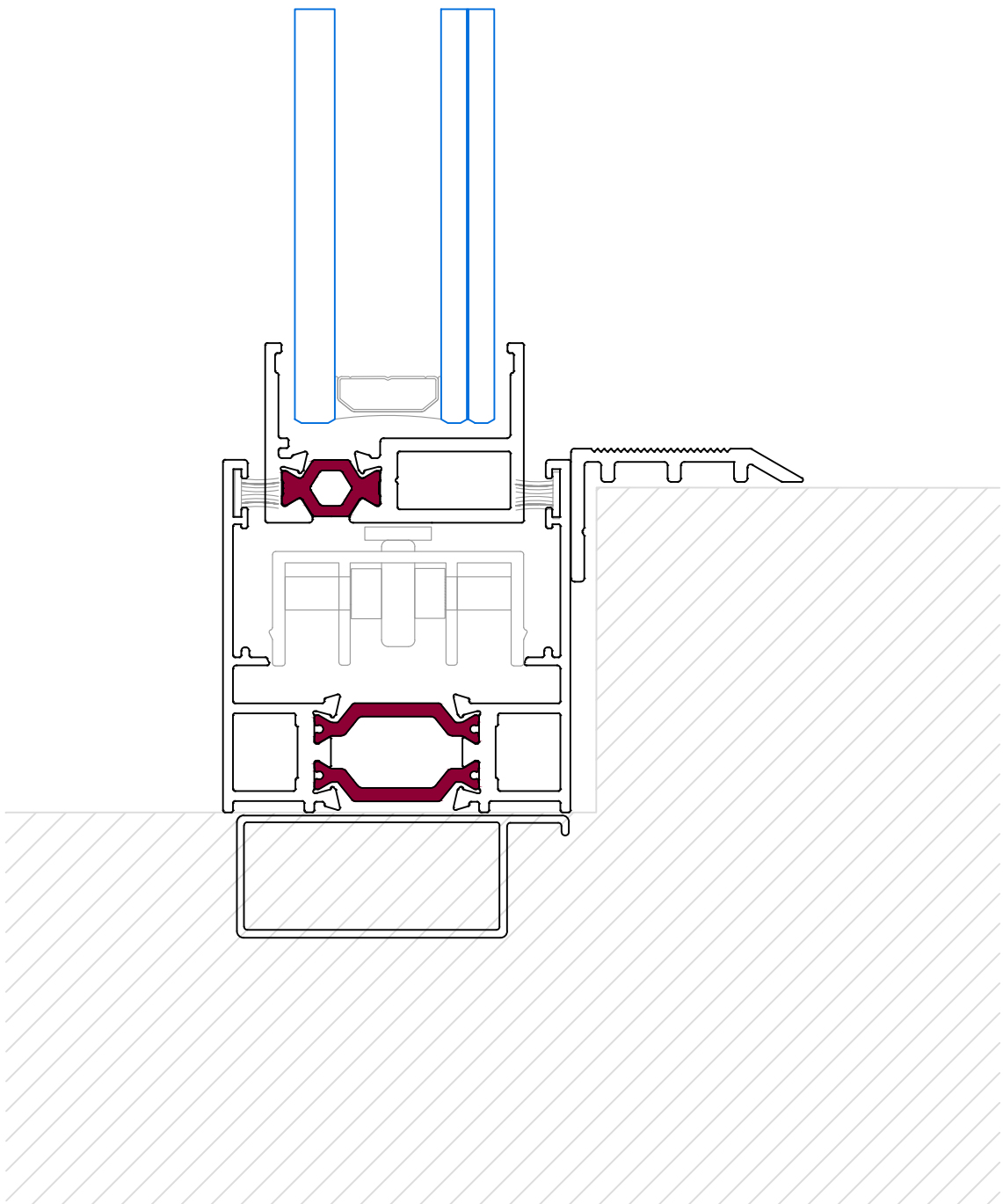
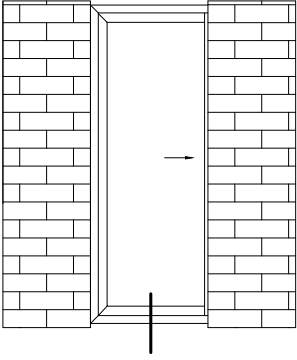

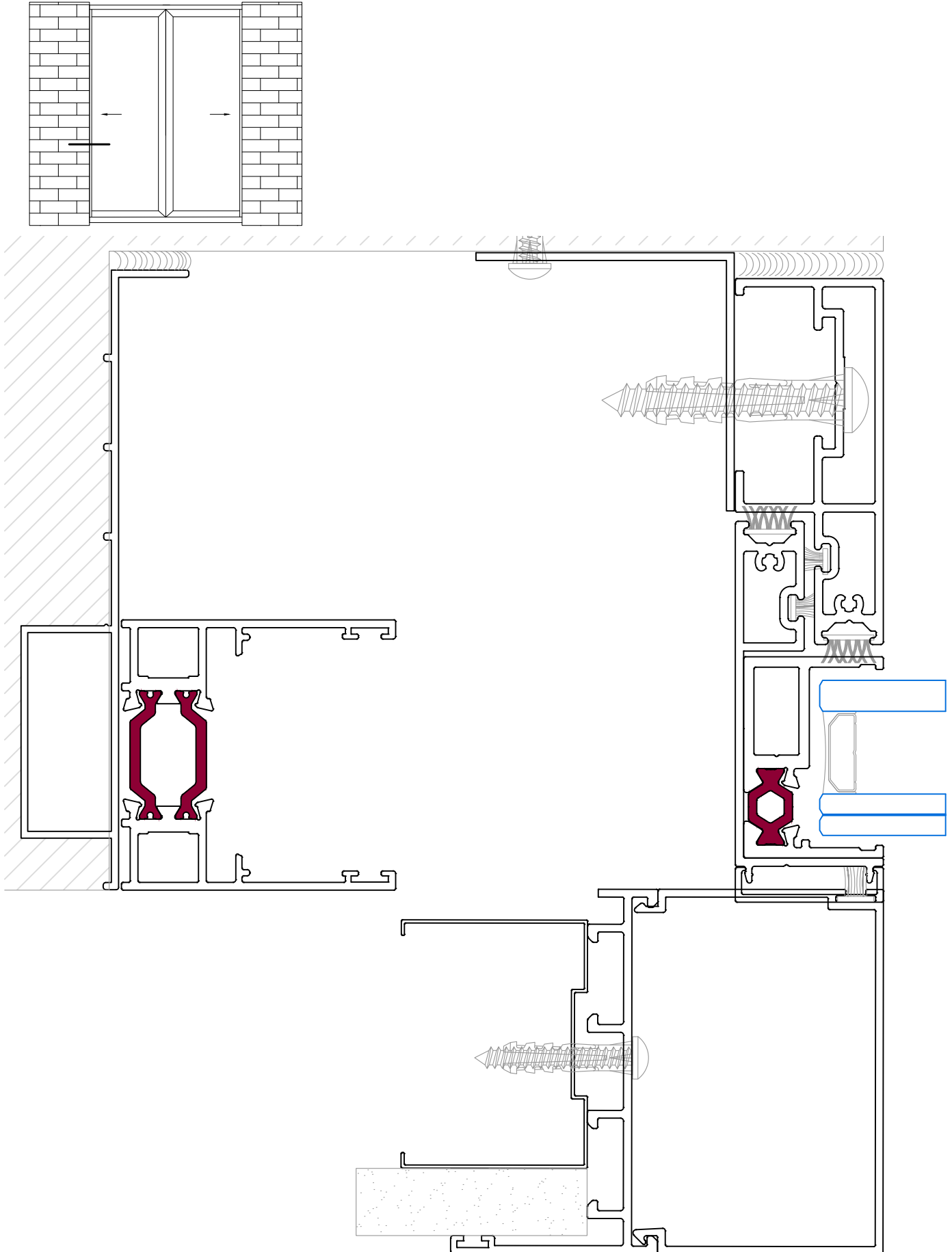

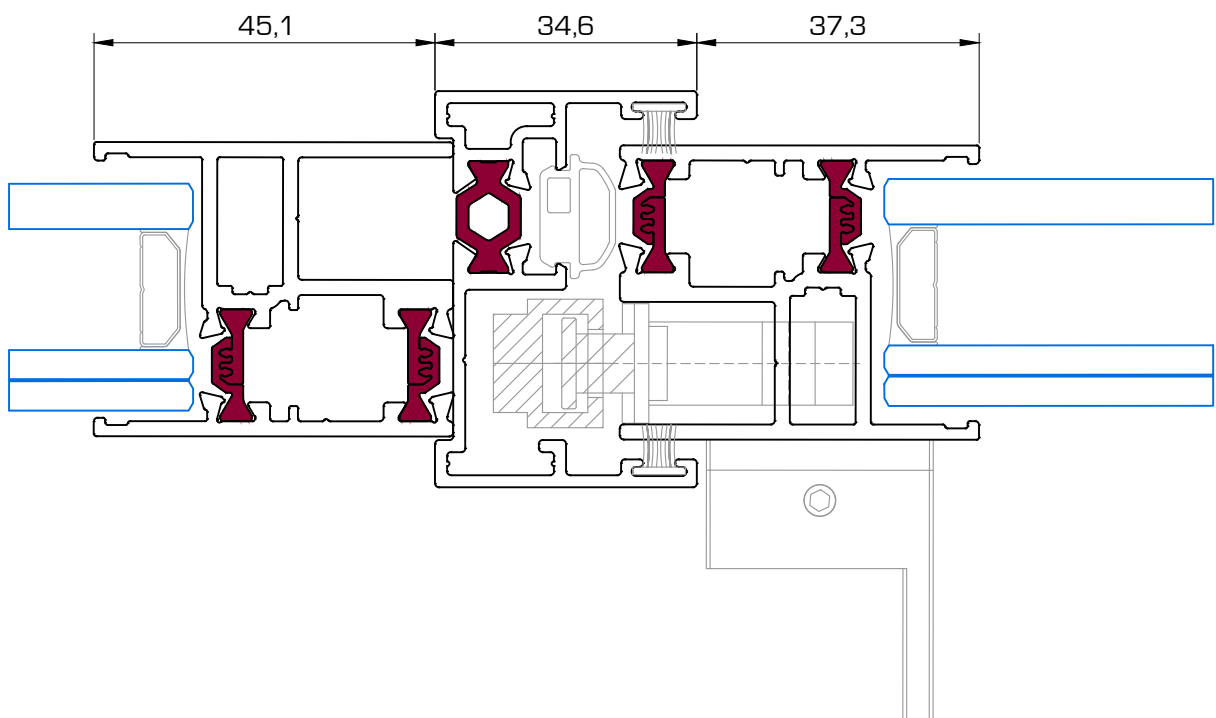
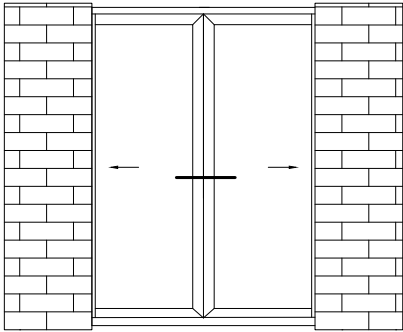



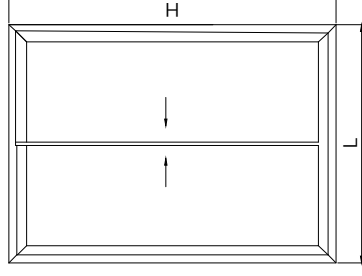





























SECCIÓN BALCONERA 2 HOJAS
RODAMIENTO REGULABLE





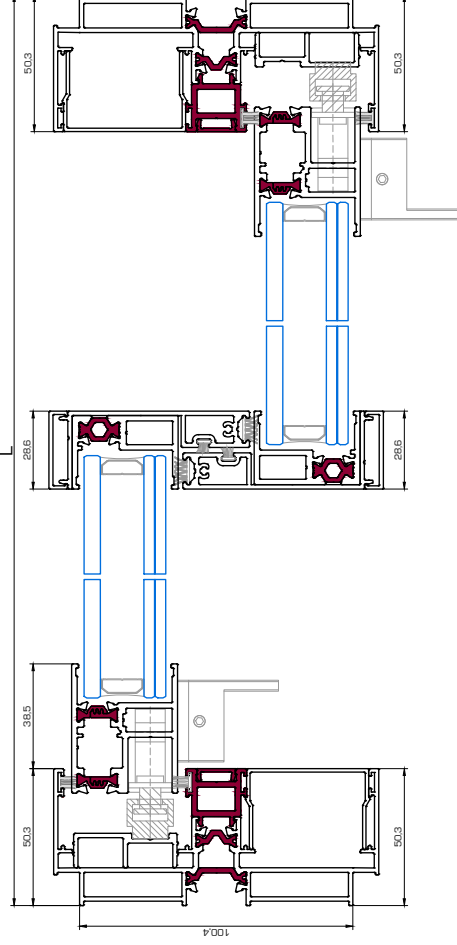
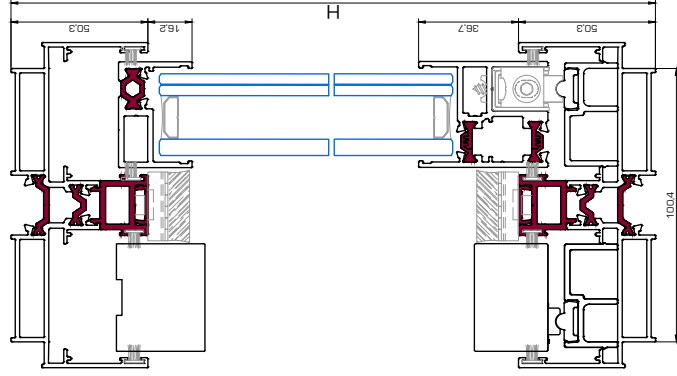



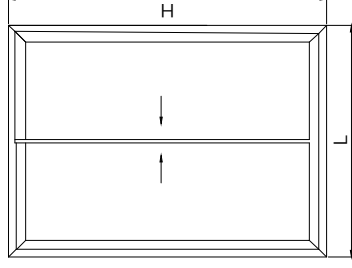













Ref.	Dibujo	Descripción	Corte	Uds.	Descuento
1000		Marco horizontal		2	L
		Marco vertical		2	H
1001		Hoja inferior		2	(L - 16) / 2
		Hoja lateral		2	H - 54
1005		Hoja superior		2	(L - 98) / 2
		Hoja centro		2	H - 95
1002		Hoja centro		2	H - 132
1015		Tapete hoja centro		2	H - 132
1016		Tapete marco lateral		2	H - 45
1010		Suplemento carril de rodadura		4	(L - 77) / 2
1004		Carril rodadura		4	(L - 77) / 2
1012		Suplemento lateral		2	H - 28
PO-145		Tapa poliamida m. horizontal		2	L - 66
		Tapa poliamida m. vertical		2	H - 101
PO-223		Poliamida m. horizontal		2	L - 66
		Poliamida m. vertical		2	H - 101



SECCIÓN BALCONERA 2 HOJAS
 RODAMIENTO PASO 100





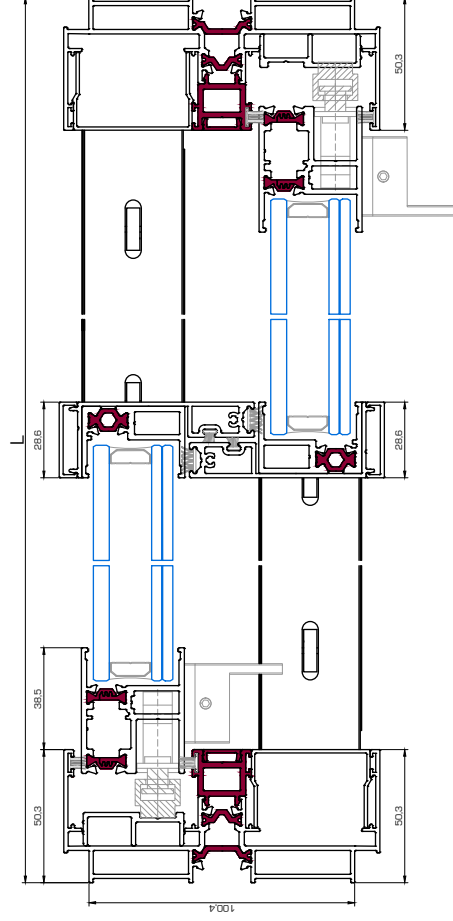
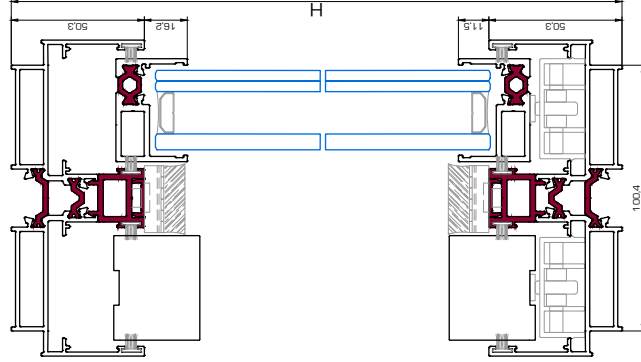



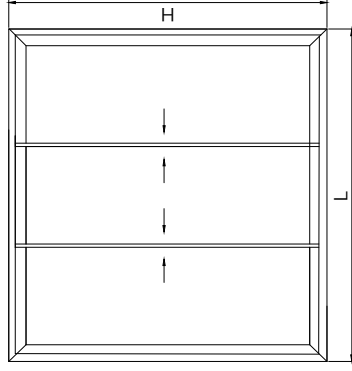

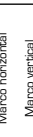
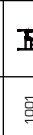

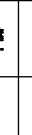
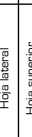

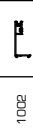

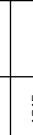

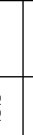

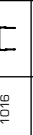



Ref.	Dibujo	Descripción	Corte	Uds.	Descuento
1000		Marco horizontal Marco vertical		2 2	L H
1001		Hoja lateral		2	H - 35
1005		Hoja superior/ inferior Hoja centro		4 2	(L - 98)/2 H - 76
1002		Hoja centro		2	H - 139
1015		Tapeta hoja centro		2	H - 139
1016		Tapeta marco lateral		2	H - 45
1012		Suplemento lateral cerrado		2	H - 28
PO-145		Tapa poliamida m. horizontal		2	L - 96
PO-223		Tapa poliamida m. vertical		2	H - 101
		Poliamida m. horizontal		2	L - 66
		Poliamida m. vertical		2	H - 101

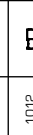
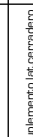
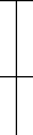
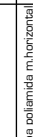
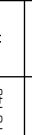

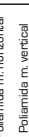
SECCIÓN BALCONERA 3 HOJAS MARCO 3 CARRILES
 RODAMIENTO REGULABLE

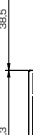



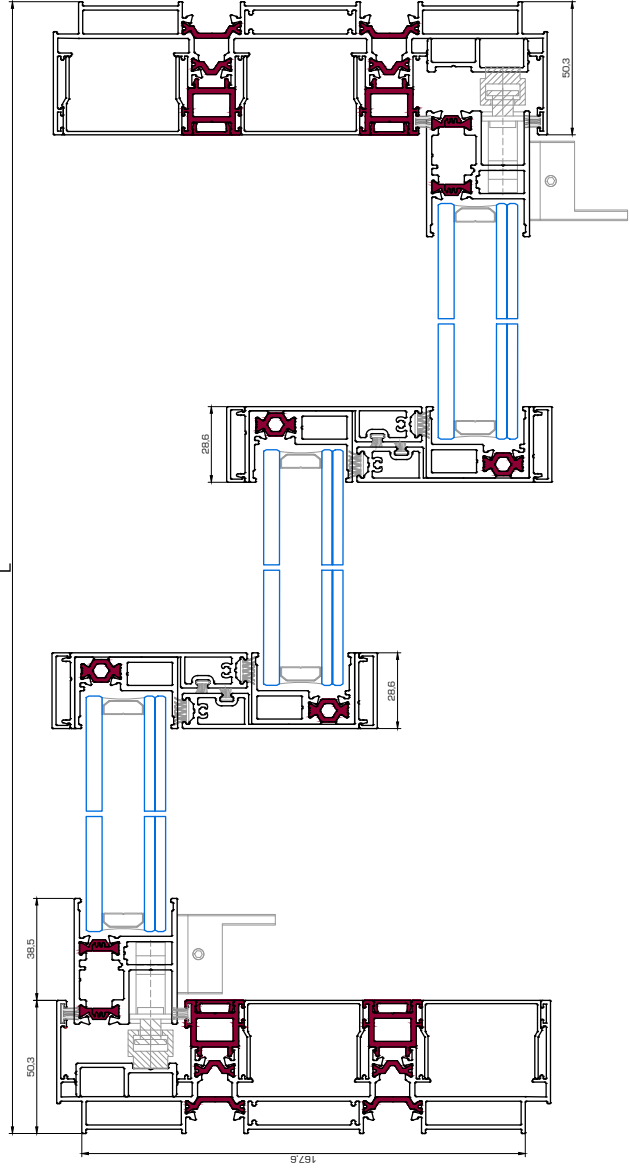
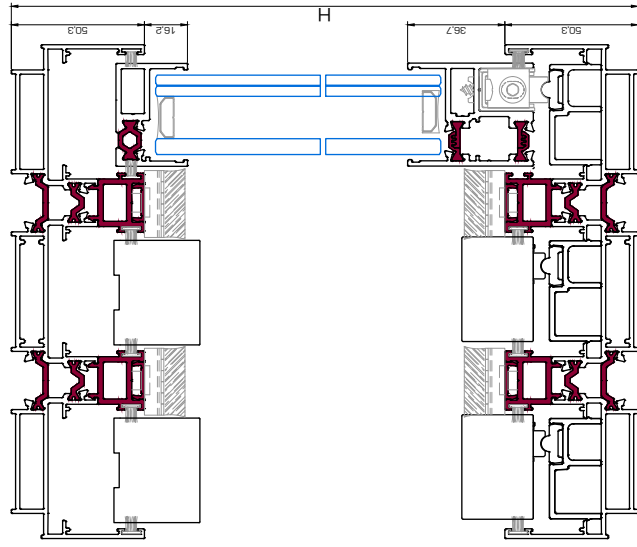



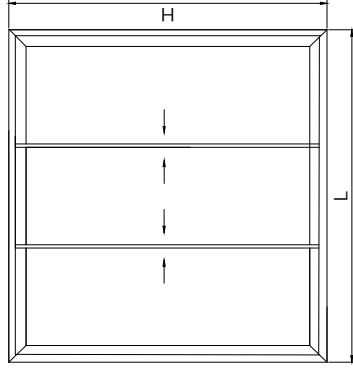











Ref.	Dibujo	Descripción	Cante	Uds.	Descuento
1006		Marco horizontal		2	L
		Marco vertical		2	H
1001		Hoja inferior		3	(L + 50)/3
		Hoja lateral		2	H - 54
1005		Hoja superior		3	(L - 73)/3
		Hoja centro		4	H - 95
1002		Hoja centro		4	H - 132
1015		Tapeta hoja centro		4	H - 132
1016		Tapeta marco lateral		2	H - 45
1010		Suplemento carril de rodadura		3	(L - 77)/2
1004		Carril rodadura		3	(L - 77)/2
1012		Suplemento lat. centrado		2	H - 28
PO-145		Tapeta poliamida m. horizontal		4	L - 66
		Tapeta poliamida m. vertical		4	H - 101
PO-223		Poliamida m. horizontal		4	L - 66
		Poliamida m. vertical		4	H - 101



SECCIÓN BALCONERA 3 HOJAS MARCO 3 CARRILES
 RODAMIENTO PASO 100





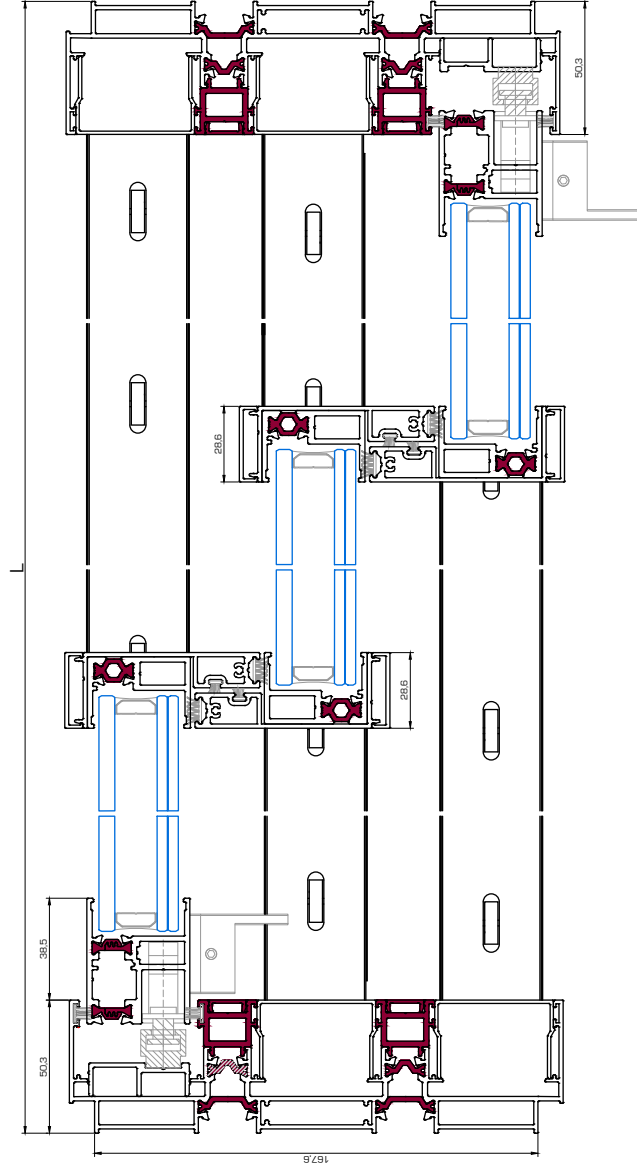
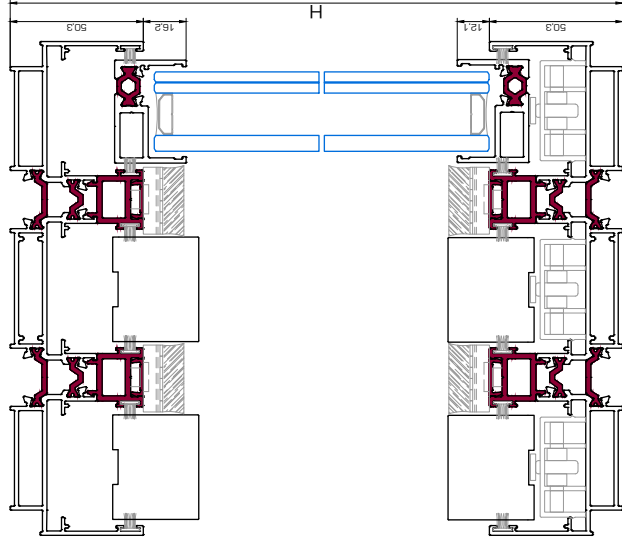



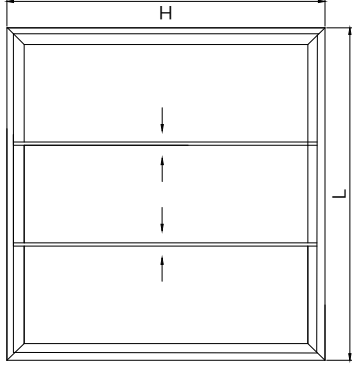

























Ref.	Dibujo	Descripción	Corte	Ldis.	Descuento
1006		Marco horizontal Marco vertical		2 2	L H
1001		Hoja lateral		2	H - 35
1005		Hoja superior/ inferior Hoja centro		6 4	(L - 73) / 3 H - 76
1002		Hoja centro		4	H - 139
1015		Tapeta hoja centro		4	H - 139
1016		Tapeta marco lateral		4	H - 45
1012		Suplemento lat.cerradero		2	H - 28
PO-145		Tapeta poliamida m. horizontal Tapeta poliamida m. vertical		4 4	L - 96 H - 101
PO-223		Poliamida m. horizontal Poliamida m. vertical		4 4	L - 66 H - 101



SECCIÓN BALCONERA 3 HOJAS MARCO 2 CARRILES
 RODAMIENTO REGULABLE





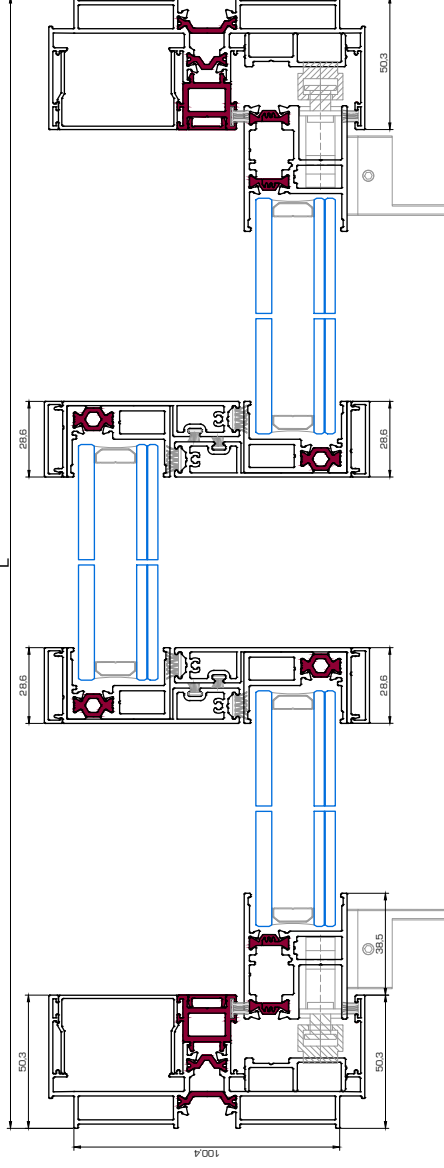
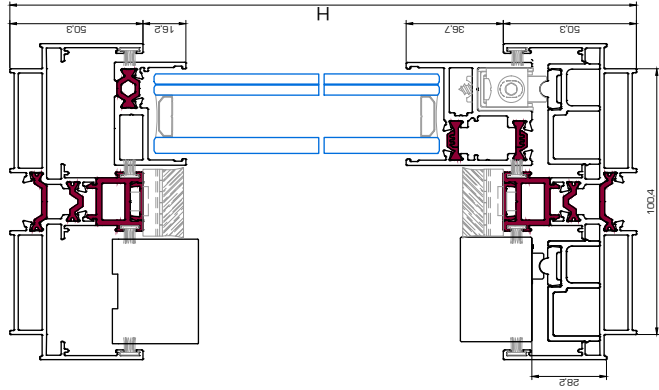



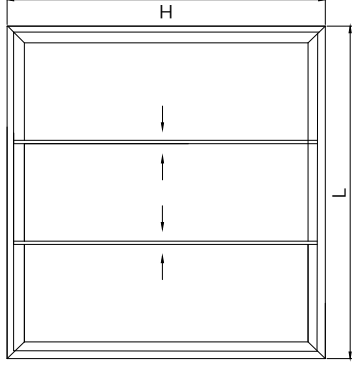























Ref.	Dibujo	Descripción	Corte	Uds.	Descuento
1000		Marco horizontal		2	L
		Marco vertical		2	H
1001		Hoja inferior		3	(L + 50)/3
		Hoja lateral		2	H - 54
1005		Hoja superior		3	(L - 73)/3
		Hoja centro		4	H - 95
1002		Hoja centro		4	H - 132
1015		Tapesa hoja centro		4	H - 132
1016		Tapeta marco lateral		2	H - 45
1010		Suplemento carril de rodadura		2	(L - 77) / 2
1004		Carril rodadura		2	(L - 77) / 2
1012		Suplemento lateral		2	H - 28
PO-145		Tapia poliamida m. horizontal		2	L - 66
		Tapia poliamida m. vertical		2	H - 101
PO-223		Poliamida m. horizontal		2	L - 66
		Poliamida m. vertical		2	H - 101



SECCIÓN BALCONERA 3 HOJAS MARCO 2 CARRILES
 RODAMIENTO PASO 100





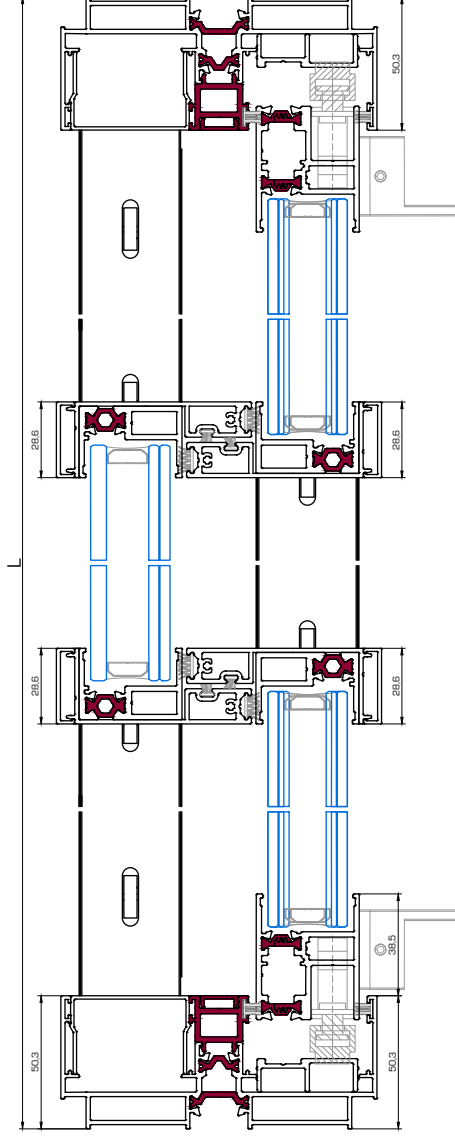
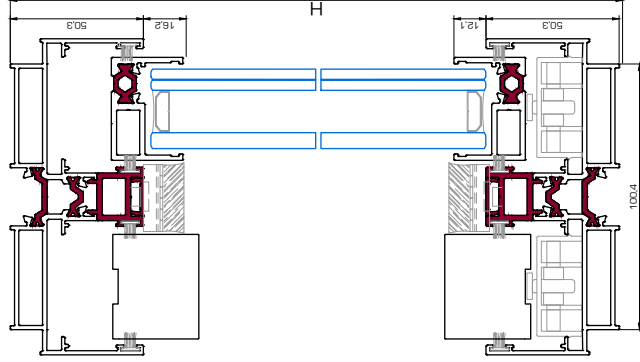



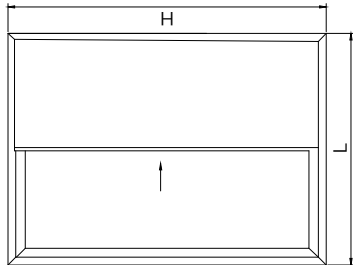

































Ref.	Dibujo	Descripción	Corte	Unid.	Descuento
1000		Marco horizontal		2	L
		Marco vertical		2	H
1001		Hoja lateral		2	H-35
1005		Hoja superior/inferior		6	(L-73)/3
		Hoja centro		4	H-76
1002		Hoja centro		4	H-139
1015		Tapeta hoja centro		4	H-139
1016		Tapeta marco lateral		2	H-45
1010		Suplemento carril de rodadura		3	(L-77)/2
1004		Carril rodadura		3	(L-77)/2
1012		Suplemento lat.cerradero		2	H-28
PO-145		Tapeta poliamida m. horizontal		2	L-66
		Tapeta poliamida m. vertical		2	H-101
PO-223		Poliamida m. horizontal		2	L-66
		Poliamida m. vertical		2	H-101



SECCIÓN BALCONERA 1 HOJA + FIJO RODAMIENTO REGULABLE





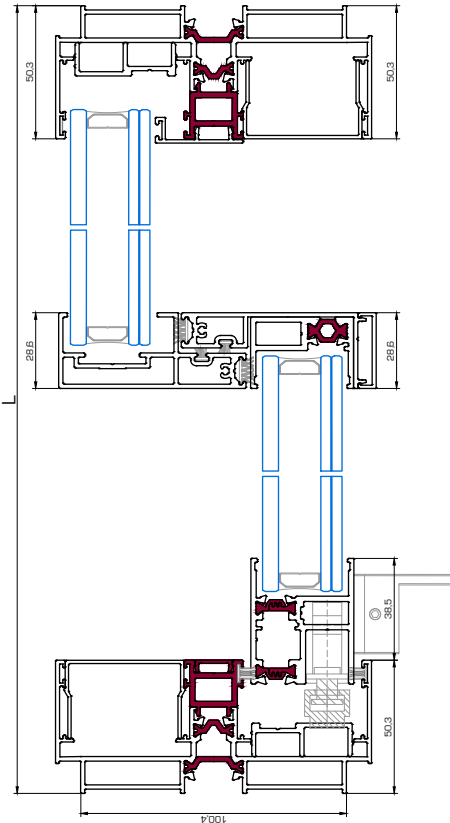
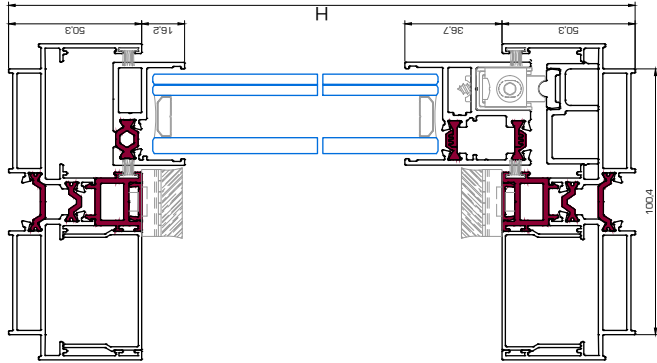



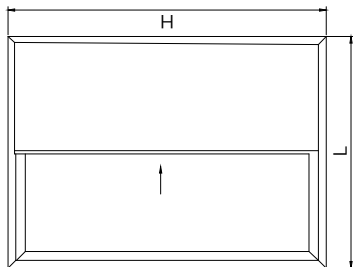



























Ref.	Dibujo	Descripción	Corte	Uds.	Descuento
1000		Marco horizontal		2	L
		Marco vertical		2	H
1001		Hoja inferior		1	(L - 16)/2
		Hoja lateral		1	H - 54
1005		Hoja superior		1	(L - 98)/2
		Hoja centro		1	H - 95
1002		Hoja centro		1	H - 132
1015		Tapete hoja centro		1	H - 132
1016		Tapete marco sup. e inf.		2	(L - 128)/2
		Tapete marco lateral		2	H - 55
1013		Plastre fijo integrado		1	H - 42
1011		Junquillo sup. e inf.		2	(L - 128)/2
		Junquillo lateral		1	H - 102
1010		Suplemento camil de rodadura		1	L - 28
1004		Camil rodadura		1	L - 28
1012		Suplemento lateral		2	H - 67
PO-145		Tapete poliamida m. horizontal		2	(L - 96)/2
		Tapete poliamida m. vertical		2	H - 101
PO-223		Poliamida m. horizontal		2	(L - 96)/2
		Poliamida m. vertical		2	H - 101



SECCIÓN BALCONERA 1 HOJA + FIJO
 RODAMIENTO PASO 100





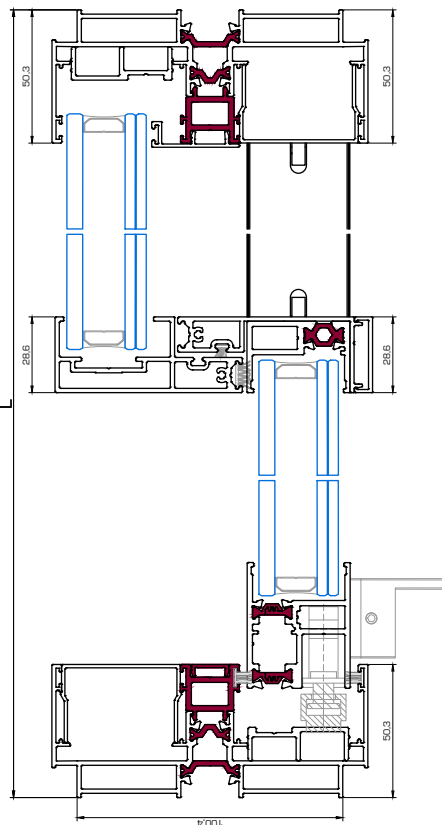
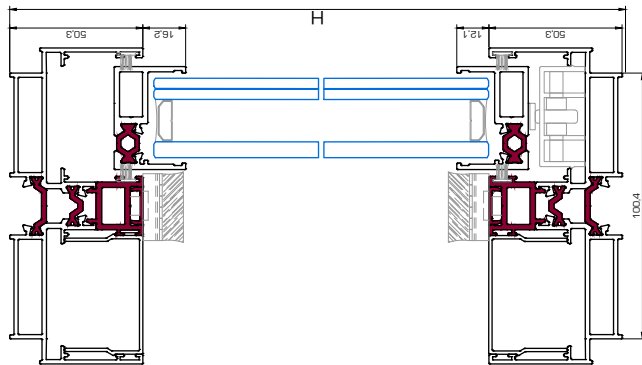



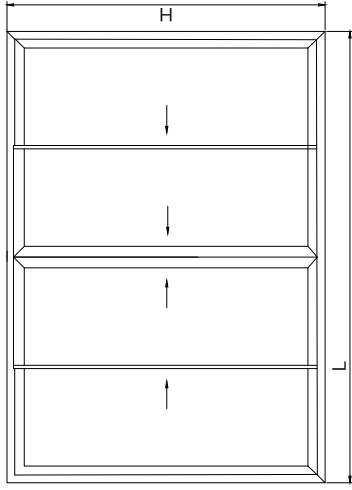



























Ref.	Dibujo	Descripción	Corte	Uds.	Descuento
1000		Marco horizontal		2	L
		Marco vertical		2	H
1001		Hoja lateral		1	H-35
1005		Hoja superior/inferior		2	(L-98)/2
		Hoja centro		1	H-76
1002		Hoja centro		1	H-139
1015		Tapete hoja centro		1	H-139
1016		Tapete marco sup. e inf.		2	(L-129)/2
		Tapete marco lateral		2	H-44
1013		Plastre fijo integrado		1	H-42
1011		Junquillo sup. e inf.		2	(L-129)/2
		Junquillo lateral		1	H-102
1012		Suplemento lat. cerrado		2	H-28
PO145		Tapete poliéster m. horizontal		2	(L-98)/2
		Tapete poliéster m. vertical		2	H-101
PO223		Poliéster m. horizontal		2	(L-98)/2
		Poliéster m. vertical		2	H-101



SECCIÓN BALCONERA 4 HOJAS
 RODAMIENTO REGULABLE





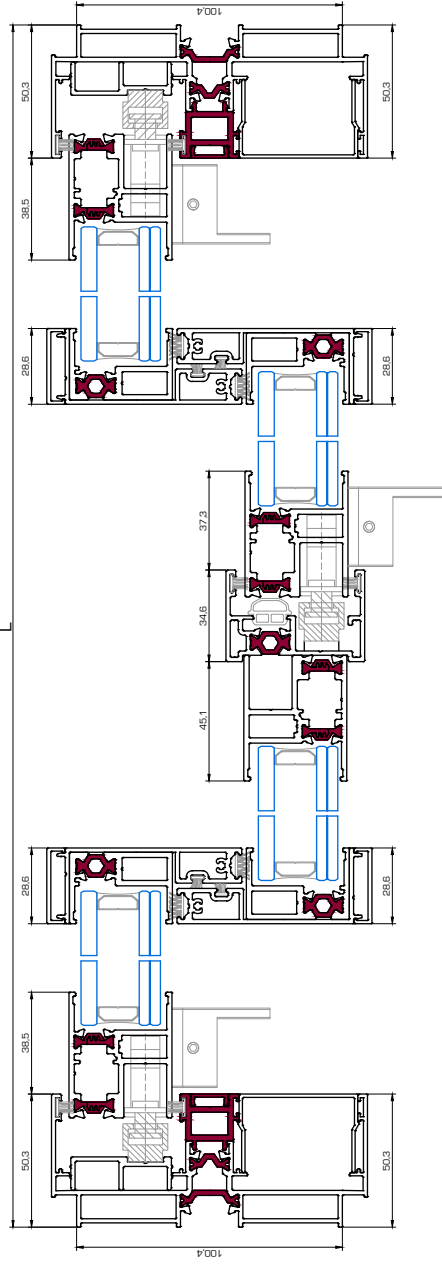
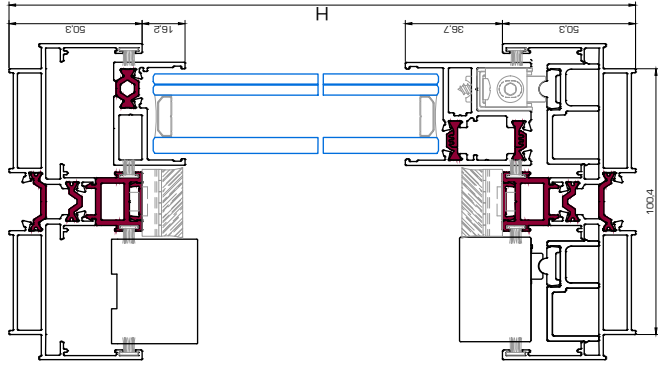



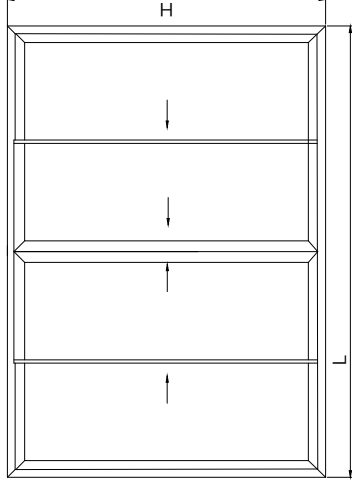























Ref.	Dibujo	Descripción	Corte	Uds.	Descuento
1000		Marco horizontal		2	L
1001		Marco vertical		2	H
1005		Hoja inferior		4	(L - 28)/4
1006		Hoja lateral		4	H - 54
1005		Hoja superior		4	(L - 138)/4
1002		Hoja centro		4	H - 95
1015		Hoja centro		4	H - 132
1015		Tapesa hoja centro		4	H - 132
1016		Tapeta marco lateral		2	H - 45
1010		Suplemento carril de rodadura		2	(L - 77) / 2
1004		Carril rodadura		2	(L - 77) / 2
1012		Suplemento lateral		2	H - 28
1009		Unión 4 hojas		1	H - 142
PO-145		Tapia poliámda m. horizontal		2	L - 66
PO-223		Tapia poliámda m. vertical		2	H - 101
PO-223		Poliámda m. horizontal		2	L - 66
PO-223		Poliámda m. vertical		2	H - 101



SECCIÓN BALCONERA 4 HOJAS
 RODAMIENTO PASO 100





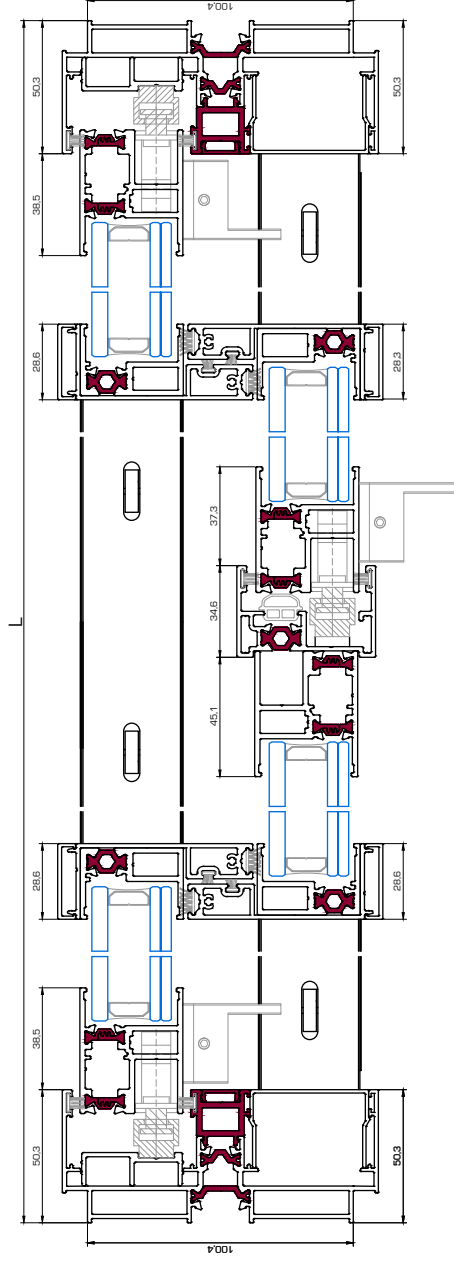
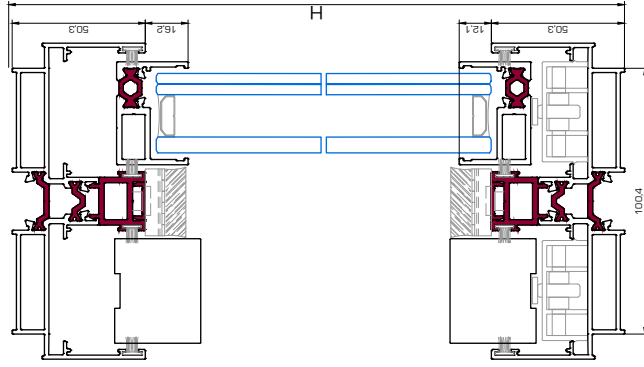



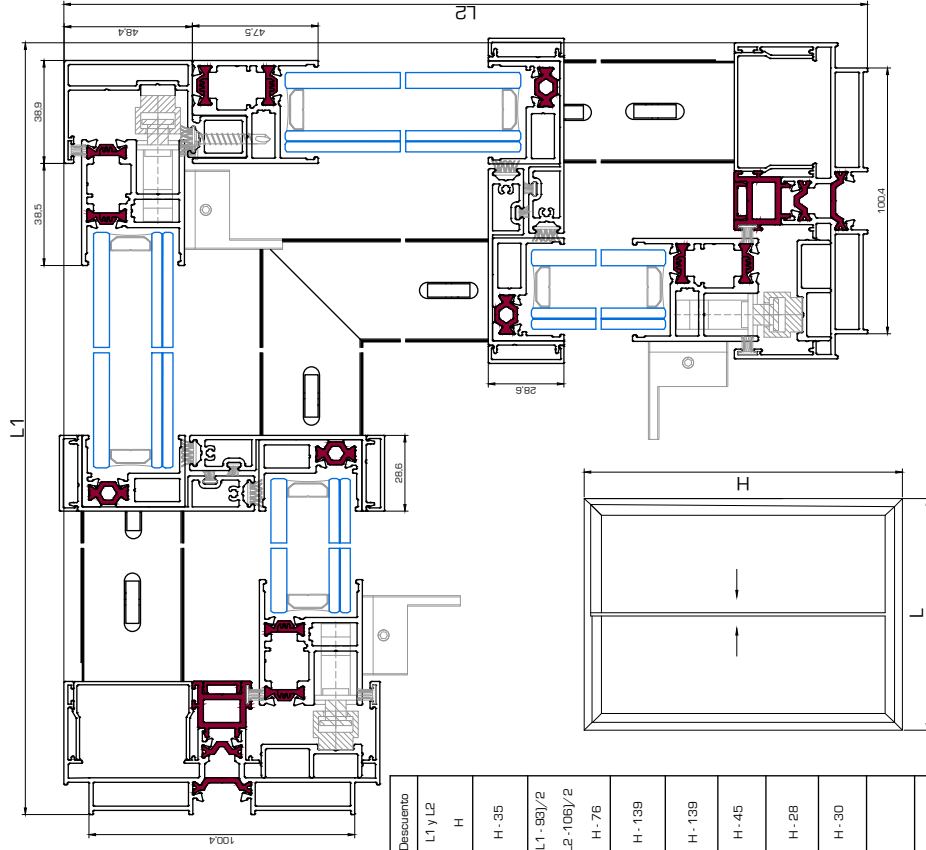























Ref.	Dibujo	Descripción	Conte	Uds.	Descuento
1000		Marco horizontal		2	L
		Marco vertical		2	H
1001		Hoja inferior		4	(L + 28)/2
		Hoja lateral		4	H - 35
1005		Hoja superior		4	(L - 136)/4
		Hoja centro		4	H - 76
1002		Hoja centro		4	H - 139
1015		Tapeta hoja centro		4	H - 139
1016		Tapeta marco lateral		2	H - 45
1012		Suplemento balcón radiero		2	H - 28
1009		Unión 4 hojas		1	H - 142
PO-145		Tapa poliamida m. horizontal		2	L - 66
		Tapa poliamida m. vertical		2	H - 101
PO-223		Poliamida m. horizontal		2	L - 66
		Poliamida m. vertical		2	H - 101



SECCIÓN BALCONERA 2 HOJAS + 2 FIJAS LATERALES
 RODAMIENTO PASO 100





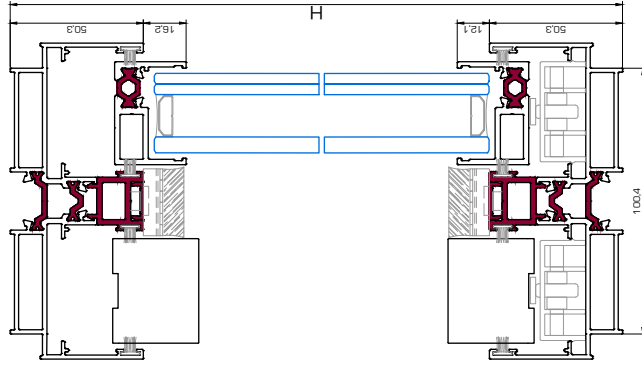



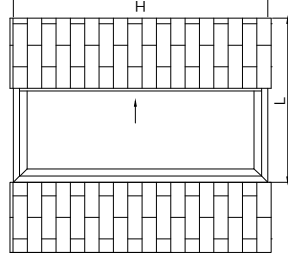





































Ref.	Dibujos	Descripción	Corte	Unid.	Descuento
1000		Marco horizontal		2	L1 y L2
		Marco vertical		2	H
1001		Hoja lateral		2	H - 35
1005		Hoja superior / inferior 1		2	(L1 - 93) / 2
		Hoja superior / inferior 2		1	(L2 - 106) / 2
		Hoja centro		2	H - 76
1002		Hoja centro		2	H - 139
1015		Tapeta hoja centro		2	H - 139
1016		Tapeta marco lateral		2	H - 45
1012		Suplemento lit.cerradero		2	H - 28
1014		Unión marco en esquina		2	H - 30
PO-145		Tapa poliamida m. horizontal		4	
		Tapa poliamida m. vertical		2	
PO-223		Poliamida m. horizontal		2	
		Poliamida m. vertical		2	









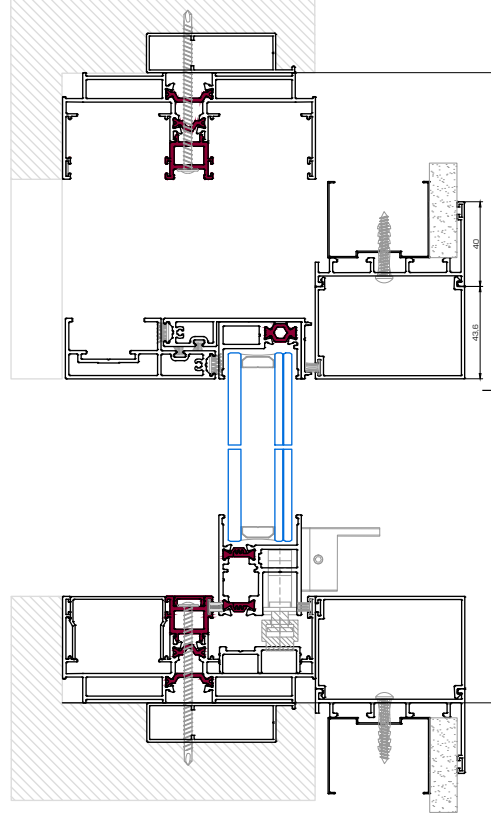
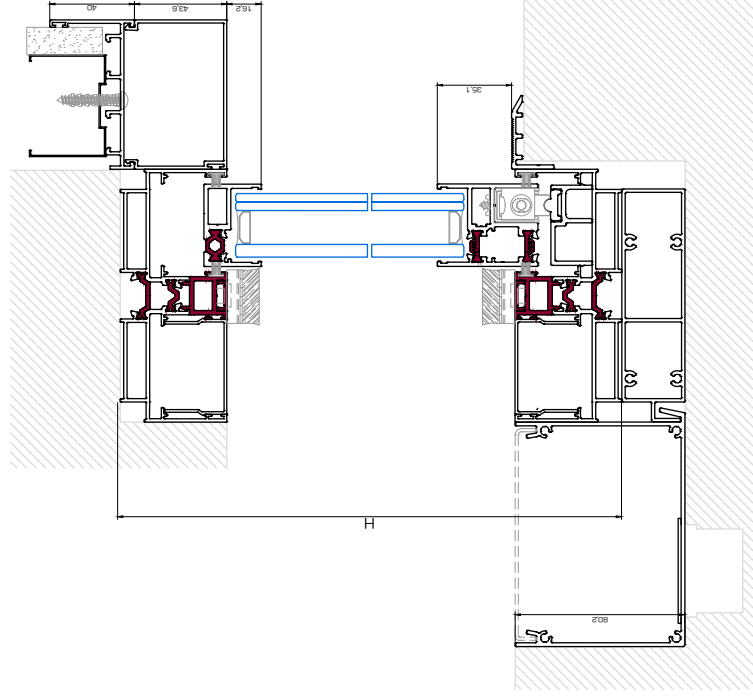



































SECCIÓN BALCONERA 1 HOJA GALANDAGE
RODAMIENTO REGULABLE Y GUÍA INF. REJILLA



Ref.	Dibujo	Descripción	Corte	Uds.	Descuento
1000		Marco horizontal		2	L
		Marco vertical		2	H
1001		Hoja inferior		1	(L - 16)/2
		Hoja lateral		1	H - 54
1005		Hoja superior		1	(L - 98)/2
		Hoja centro		1	H - 95
1002		Hoja centro		1	H - 132
1015		Tapete hoja centro		1	H - 132
1016		Tapete marco sup. e inf.		2	(L - 129)/2
		Tapete marco lateral		1	H - 45
1013		Plastina fijo integrado		1	H - 42
1010		Suplemento carril de rodadura		1	(L - 77)/2
1004		Carril rodadura		1	(L - 77)/2
1012		Suplemento latex rodado		1	H - 28
1017		Galandage horizontal		1	(L + 206)/2
		Galandage vertical		2	H + 34
1018		Tapa galandage horizontal		1	(L + 46)/2
		Tapa galandage vertical		2	H - 51
PO-145		Tapa poliámmida m. horizontal		2	L - 66
		Tapa poliámmida m. vertical		2	H - 101
PO-223		Poliámmida m. vertical		2	(L - 129)/2
		Poliámmida m. horizontal		2	H - 101







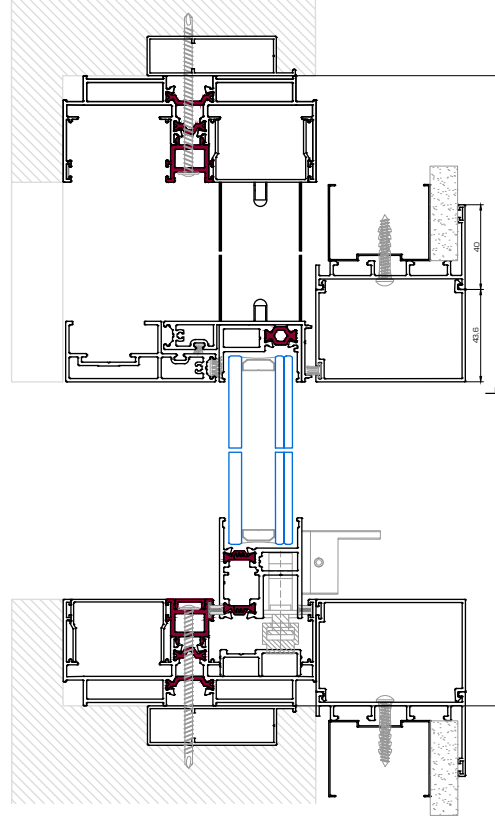
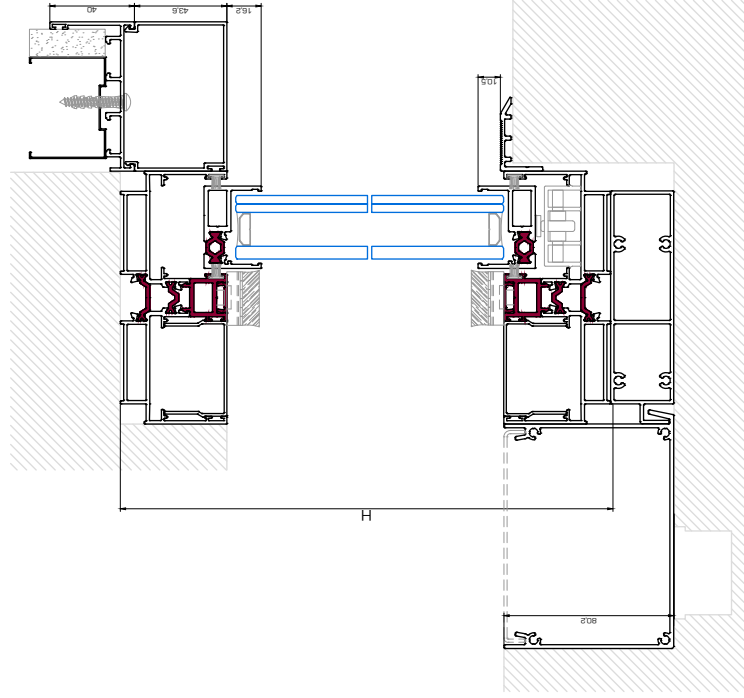
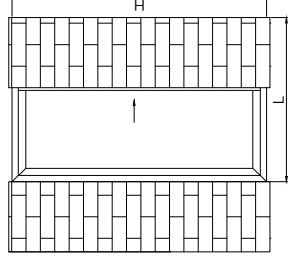



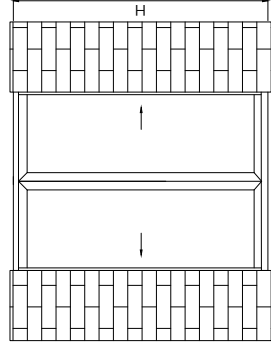

































SECCIÓN BALCONERA 1 HOJA GALANDAGE
 RODAMIENTO PASO 100 Y GUJÍA INF. REJILLA

Ref.	Dibujo	Descripción	Corte	Uds.	Descuento
1000		Marco horizontal		2	L
		Marco vertical		2	H
1001		Hoja lateral		2	H · 35
1005		Hoja superior/inferior		4	(L · 98) / 2
		Hoja centro		2	H · 76
1002		Hoja centro		1	H · 139
1015		Tapeta hoja centro		1	H · 139
1016		Tapeta marco sup. e inf.		2	(L · 128) / 2
		Tapeta marco lateral		1	H · 45
1013		Pilastro fijo integrado		1	H · 42
1010		Suplemento curvil de rodadura		1	(L · 77) / 2
1004		Carril rodadura		1	(L · 77) / 2
1012		Suplemento lat.cerradero		1	H · 28
1017		Galandage horizontal		1	(L + 205) / 2
		Galandage vertical		2	H + 34
1018		Tapeta galandage horizontal		1	(L + 46) / 2
		Tapeta galandage vertical		2	H · 51
PO-145		Tapeta poliámda m. horizontal		2	(L · 98) / 2
		Tapeta poliámda m. vertical		2	H · 101
PO-223		Poliámda m. horizontal		2	L · 66
		Poliámda m. vertical		2	H · 101



SECCIÓN BALCONERA 2 HOJAS GALANDAGE
 RODAMIENTO REGULABLE Y GUÍA INF. REJILLA





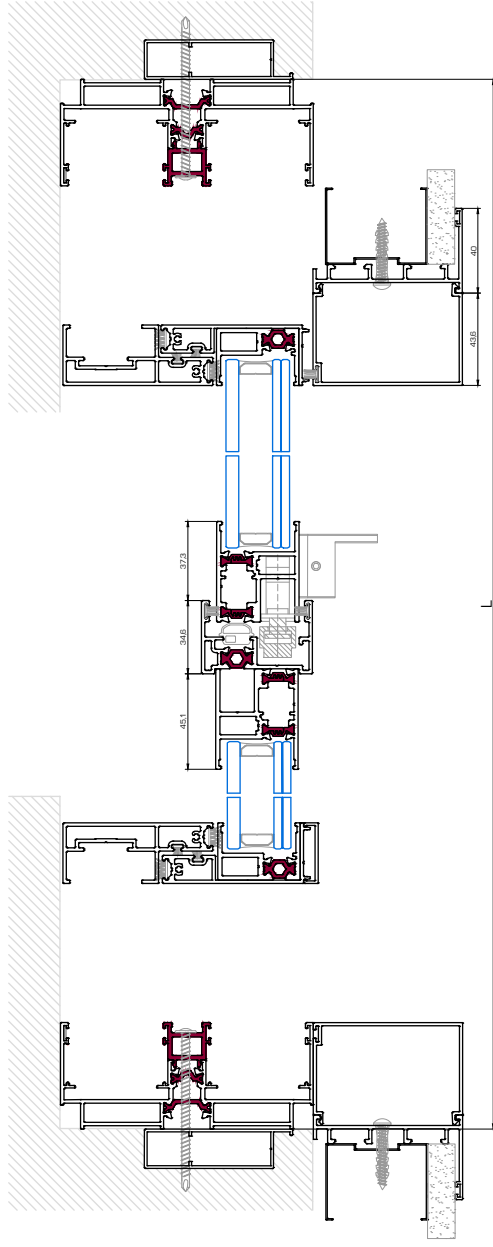
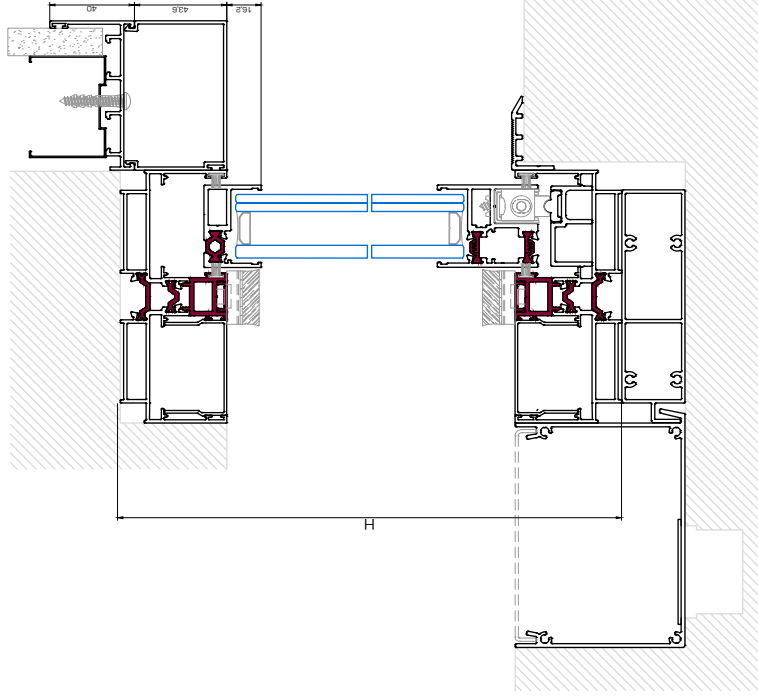



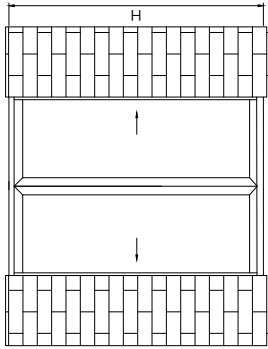































Ref.	Dibujó	Descripción	Corte	Uds.	Descuento
1000		Marco horizontal		2	L
		Marco vertical		2	H
1001		Hoja inferior		2	(L+ 28)/4
		Hoja lateral		2	H- 54
1005		Hoja superior		2	(L- 136)/4
		Hoja centro		2	H- 95
1002		Hoja centro		2	H- 132
1015		Tapeta hoja centro		1	H- 132
1016		Tapeta marco inf. / sup.		2	(L- 66)/2
1013		Pilastro fijo integrado		1	H- 42
1010		Suplemento carril de rodadura		1	(L- 77)/2
1004		Carril rodadura		1	(L- 77)/2
1009		Unión 4 hojas		1	H- 142
1017		Galandage horizontal		1	(L+ 206)/2
		Galandage vertical		2	H+ 34
1018		Tapa galandage horizontal		1	(L+ 46)/2
		Tapa galandage vertical		2	H- 51
PO145		Tapa poliamida m. horizontal		2	L- 66
		Tapa poliamida m. vertical		2	H- 101
PO223		Poliamida m. horizontal		2	L- 66
		Poliamida m. vertical		2	H- 101









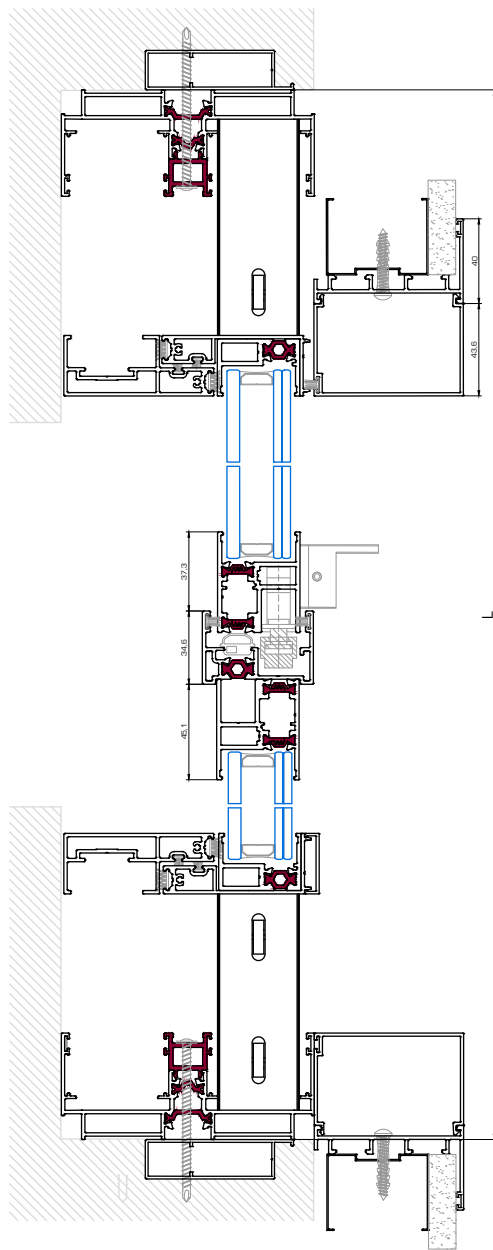
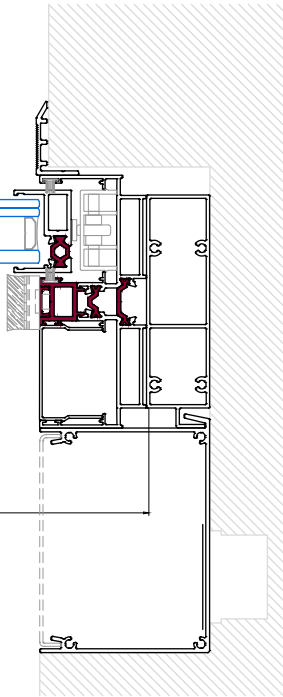
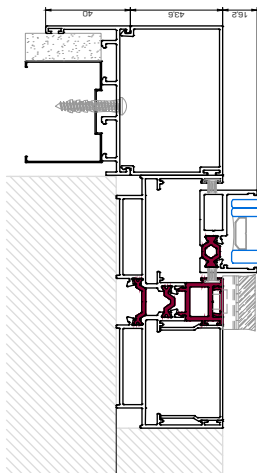





































SECCIÓN BALCONERA 2 HOJAS GALANDAGE
 RODAMIENTO PASO 100 Y GUÍA INF. REJILLA



Ref.	Dibujo	Descripción	Corte	Uds.	Descuento
1000		Marco horizontal		2	L
		Marco vertical		2	H
1001		Hoja inferior		2	(L+28)/4
		Hoja lateral		2	H-35
1005		Hoja superior		2	(L-138)/4
		Hoja centro		2	H-76
1002		Hoja centro		2	H-139
1015		Tapeta hoja centro		2	H-139
1016		Tapeta marco inf. / sup.		2	(L-66)/2
1013		Plastira fijo integrado		1	H-42
1009		Unión 4 hojas		1	H-142
1017		Galandage horizontal		1	(L/2)/+36
		Galandage vertical		2	H+16
1018		Tapa galandage horizontal		1	(L+66)/2
		Tapa galandage vertical		2	H-24
PD-145		Tapa poliamida m. horizontal		2	L-66
		Tapa poliamida m. vertical		2	H-101
PD-223		Pelamida m. horizontal		2	L-66
		Pelamida m. vertical		2	H-101



SECCIÓN BALCONERA MONORRAIL 1 HOJA GALANDAGE RODAMIENTO REGULABLE

Ref.	Dibujo	Descripción	Corte	Uds.	Desarrollo
1008		Marco horizontal		2	L
		Marco vertical		2	H
1001		Hoja inferior		1	(L-16)/2
		Hoja lateral		1	H-54
1005		Hoja superior		1	(L-98)/2
		Hoja centro		1	H-95
1002		Hoja centro		1	H-132
1015		Tapeta hoja centro		1	H-132
1016		Tapeta marco lateral		1	H-45
		Tapeta marco inf. / sup.		2	(H-129)/2
1013		Placa fijo integrado		1	H-42
1010		Suplemento carril de rodadura		1	(L-77)/2
1004		Carril rodadura		1	(L-77)/2
1012		Suplemento lateralizado		1	H-28
1017		Galandage horizontal		1	(L+206)/2
		Galandage vertical		2	H+34
1018		Tapa galandage horizontal		1	(L+46)/2
		Tapa galandage vertical		2	H-51
PO-145		Tapa poliamida m. horizontal		2	L-66
		Tapa poliamida m. vertical		2	H-101
PO-223		Poliamida m. horizontal		2	(L-129)/2
		Poliamida m. vertical		2	H-101

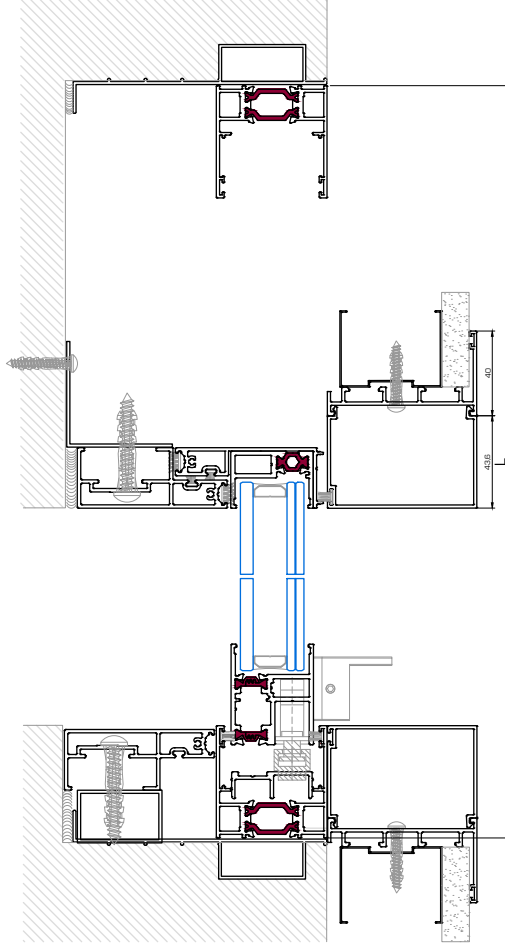
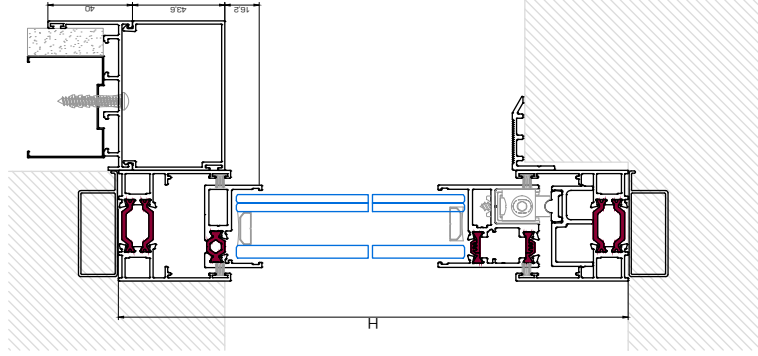
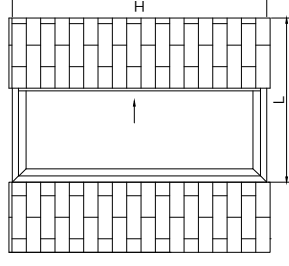

SECCIÓN BALCONERA MONIRRAIL 1 HOJA GALANDAGE
 RODAMIENTO PASO 100 Y GUÍA INF. REJILLA

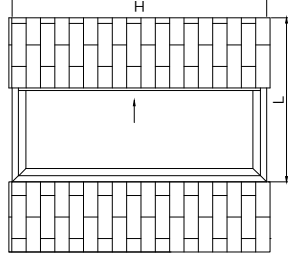

Ref.	Dibujo	Descripción	Canta	Uds.	Descuento
1008		Marco horizontal		2	L
		Marco vertical		2	H
1001		Hoja lateral		1	H-35
1005		Hoja superior		1	(L-96)/2
		Hoja centro		1	H-76
1002		Hoja centro		1	H-139
1015		Tapeta hoja centro		1	H-139
1016		Tapeta marco lateral		1	H-45
		Tapeta marco inf. / sup.		2	(H-129)/2
1013		Placa fijo integrado		1	H-42
1010		Suplemento carril de rodadura		1	(L-77)/2
1004		Carril rodadura		1	(L-77)/2
1012		Suplemento lat. cerrado		1	H-28
1017		Galandage horizontal		1	(L+206)/2
		Galandage vertical		2	H-34
1018		Tapa galandage horizontal		1	(L+46)/2
		Tapa galandage vertical		2	H-51
PO-145		Tapa poliamida m. horizontal		2	(L-96)/2
		Tapa poliamida m. vertical		2	H-101
PO-223		Poliamida m. horizontal		2	L-66
		Poliamida m. vertical		2	H-101

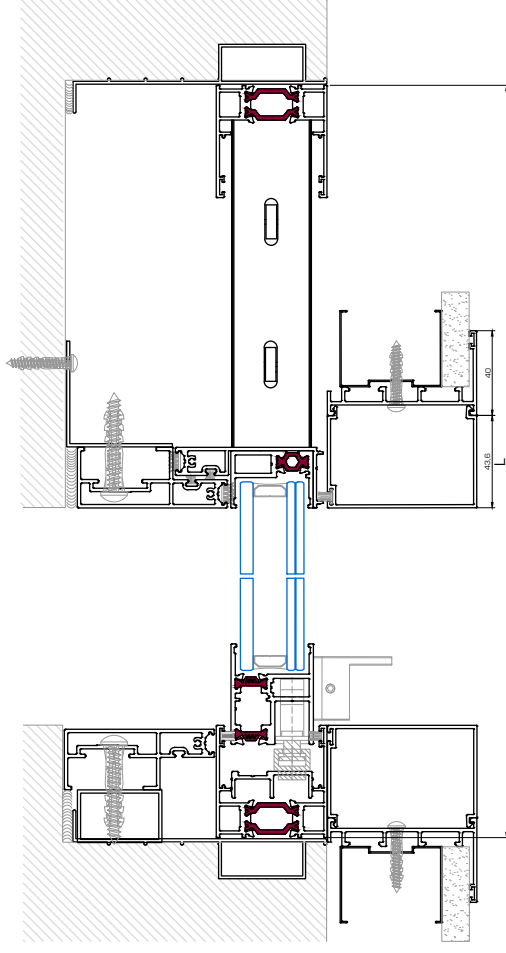
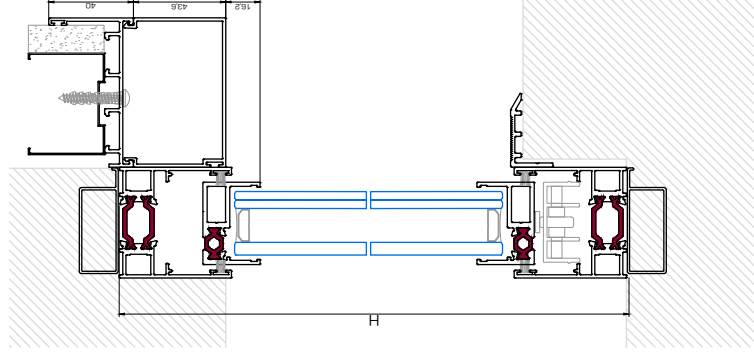



ALUES S.L

Polígono Industrial P29

Calle Tinte nº 4

28400 - Collado Villalba - Madrid
España

Telf: 910641620 / 661 621162

alues@aluessistemas.com